

# KENWOOD

## DNX995S DNX875S

### GPS NAVIGATION SYSTEM INSTRUCTION MANUAL

JVC KENWOOD Corporation

- Updated information (the latest Instruction Manual, system updates, new functions, etc.) is available from <http://www.kenwood.com/cs/ce/>.
- The Instruction manual is subject to change for modification of specifications and so forth. Be sure to download the latest edition of the Instruction manual for reference. <http://manual.kenwood.com/edition/im396/>

**Take the time to read through this instruction manual.**

**Familiarity with installation and operation procedures will help you obtain the best performance from your new GPS Navigation System.**

#### **For your records**

Record the serial number, found on the back of the unit, in the spaces designated on the warranty card, and in the space provided below. Refer to the model and serial numbers whenever you call upon your KENWOOD dealer for information or service on the product.

Model DNX995S/ DNX875S Serial number \_\_\_\_\_

#### **US Residence Only**

### **Register Online**

Register your KENWOOD product at [www.kenwood.com/usa/](http://www.kenwood.com/usa/)

# Contents

## **Before Use 4**

Precautions.....	4
Safety Precautions and Important Information .....	5
How to read this manual .....	6

## **Basic Operations 7**

Functions of the Buttons on the Front Panel ...	7
Turning on the Unit .....	8
Initial Settings.....	9
Adjusting the volume .....	10
Monitor Angle Control .....	10
Touch screen operations .....	11
HOME screen descriptions.....	11
Popup menu .....	12
Source selection screen description.....	12
Source control screen descriptions .....	14
List screen .....	15
Navigation Operation .....	16

## **Widget 20**

Widget .....	20
Weather Widget .....	20
Photo Frame Widget .....	20
Widget Setup .....	21

## **Disc 22**

Playing a disc .....	22
DVD/VCD Basic Operation.....	22
Music CD/ Disc media Basic Operation .....	24
File search Operation .....	25
DVD Disc Menu Operation.....	26
DVD Setup.....	27

## **APPS—Android Auto™/ Apple CarPlay 28**

Apple CarPlay Operation .....	28
Android Auto™ Operation .....	29
WebLink™/Waze Operation .....	31
Spotify Operation.....	32
Pandora® Operation .....	34

## **USB/SD 36**

Connecting a USB device .....	36
Inserting the SD .....	36
USB/SD Basic Operation.....	37
Search Operation.....	38

## **iPod/iPhone 39**

Preparation .....	39
iPod/iPhone Basic Operation .....	40
Search Operation.....	41

## **HD Radio™ Tuner 42**

HD Radio Tuner Basic Operation.....	42
Receive Mode .....	44
Memory Operation .....	44
Selecting Operation .....	44
Bookmark.....	46
Alert Message .....	47

**SiriusXM® 48**

SiriusXM® Basic Operation .....48  
Storing Channels in Preset Memory.....50  
Preset select .....50  
Direct search .....50  
Category/Channel search.....51  
Replay .....51  
TuneMix™ .....52  
SmartFavorites, TuneStart™ .....52  
TuneScan™ .....52  
Traffic & Weather Now™ .....53  
Content Alerts.....53  
SportsFlash™ .....54  
SiriusXM Setup .....54

**Bluetooth Control 60**

Information for using Bluetooth® devices.....60  
Register the Bluetooth device .....61  
Bluetooth Setup.....61  
Playing the Bluetooth Audio Device .....63  
Using the Hands-Free Unit.....65  
Hands-Free Setup.....70

**Other External Components 71**

View Camera .....71  
Use Dashboard Camera.....73  
External audio/video players (AV-IN).....73  
OEM Features Operation .....74

**Setup 75**

Monitor Screen Setup.....75  
System Setup .....75  
User Interface Setup.....76  
Special Setup .....77  
Display Setup.....78  
AV Setup .....80

**Controlling Audio 81**

Speaker/ X'over setup .....81  
Controlling General Audio .....82  
Equalizer Control .....83  
Volume Offset.....84  
Zone Control .....84  
Sound Effect .....85  
Listening Position/ DTA.....86  
Audio Setup memory .....87

**Remote control 88**

Battery Installation.....88  
Functions of the Remote control Buttons .....88

**Connection/Installation 91**

Before Installation .....91  
Installing the unit .....93

**Troubleshooting 99**

Problems and Solutions .....99  
Error Messages .....99

**Appendix 101**

Playable Media and Files..... 101  
Region Codes in the World ..... 103  
DVD Language Codes..... 104  
Specifications..... 105  
About this Unit ..... 108

# Before Use

## Precautions

### ▲ WARNINGS

#### ■ To prevent injury or fire, take the following precautions:

- To prevent a short circuit, never put or leave any metallic objects (such as coins or metallic tools) inside the unit.
- Do not watch or fix your eyes on the unit's display when you are driving for any extended period.
- If you experience problems during installation, consult your KENWOOD dealer.

#### ■ Precautions on using this unit

- When you purchase optional accessories, check with your KENWOOD dealer to make sure that they work with your model and in your area.
- You can select a language to display menus, audio file tags, etc. See **User Interface Setup (P.76)**.
- The Radio Data System or Radio Broadcast Data System feature won't work in areas where the service is not supported by any broadcasting station.

#### ■ Protecting the monitor

- To protect the monitor from damage, do not operate the monitor using a ball point pen or similar tool with a sharp tip.

#### ■ Cleaning the unit

- If the faceplate of this unit is stained, wipe it with a dry soft cloth such as a silicon cloth. If the faceplate is stained badly, wipe it with a cloth moistened with neutral cleaner, then wipe it again with a clean soft dry cloth.

#### NOTE

- Applying spray cleaner directly to the unit may damage its mechanical parts. Wiping the faceplate with a hard cloth or using a volatile liquid such as thinner or alcohol may scratch the surface or erase the screened print.

#### ■ Lens fogging

When you turn on the car heater in cold weather, dew may form on the lens in the disc player of the unit due to condensation. This condensation on the lens (also called lens fogging) may not allow discs to play. In such a situation, remove the disc and wait for the dew to evaporate. If the unit still does not operate normally after a while, consult your KENWOOD dealer.

#### ■ Precautions on handling discs

- Do not touch the recording surface of the disc.
- Do not stick tape etc. on the disc, or use a disc with tape stuck on it.
- Do not use disc type accessories.
- Clean the disc from the center toward the outside rim.
- When removing a disc from this unit, pull it out horizontally.
- If the disc center hole or outside rim has burrs, use the disc only after removing the burrs with a ballpoint pen etc.
- Discs that are not round cannot be used.



- 8-cm (3 inch) discs cannot be used.
- Discs with coloring on the recording surface or discs that are dirty cannot be used.
- This unit can only play the following types of CDs



- This unit may not correctly play discs which do not have the mark.
- You cannot play a disc that has not been finalized. (For the finalization process, see your writing software and your recorder's instruction manual.)

## Acquiring GPS signal

The first time you turn on this unit, you must wait while the system acquires satellite signals for the first time. This process could take up to several minutes. Make sure your vehicle is outdoors in an open area away from tall buildings and trees for fastest acquisition.

After the system acquires satellites for the first time, it will acquire satellites quickly each time thereafter.

## Caution for Smartphone Users

Simultaneously running multiple applications on your smartphone while screen sharing places heavy demand on the microprocessor of the phone, potentially affecting communication and performance.

For best results while pairing with your Kenwood receiver, please be sure to close any unused applications by performing the following steps:

Android operating system example:

- Turn off WiFi in phone settings menu.
- Close all open applications before connecting for in-car use. Hold the <Home> key and select <Close all> to close all open applications.
- Clear RAM Memory of the Android phone before connecting for in-car use. Hold the <Home> key and select <Task Manager> then select <RAM> then select <Clear memory> to clear current memory processes.



## Safety Precautions and Important Information

Read this information carefully before starting to operate the KENWOOD Car Navigation System and follow the instructions in this manual.

Neither KENWOOD nor Garmin shall be liable for problems or accidents resulting from failure to observe the instructions in this manual.

### WARNING

**Failure to avoid the following potentially hazardous situations could result in an accident or collision resulting in death or serious injury.**

When navigating, carefully compare information displayed on the navigation system to all available navigation sources, including information from street signs, visual sightings, and maps. For safety, always resolve any discrepancies or questions before continuing navigation.

Always operate the vehicle in a safe manner.

Do not become distracted by the navigation system while driving, and always be fully aware of all driving conditions. Minimize the amount of time spent viewing the screen of the navigation system while driving, and use voice prompts when possible.

Do not enter destinations, change settings, or access any functions requiring prolonged use of the navigation system controls while driving. Stop your vehicle in a safe and legal manner before attempting such operations.

Keep the system volume at a low enough level to be able to hear outside noises while driving. If you can no longer hear outside noises, you may be unable to react adequately to the traffic situation. This may cause accidents.

The navigation system will not display the correct current position of the vehicle the first time it is used after purchase, or if the vehicle battery is disconnected. GPS satellite signals will soon be received, however, and the correct position will be displayed.

Be careful of the ambient temperature. Using the navigation system at extreme temperatures can lead to malfunction or damage. Also note that the unit can be damaged by strong vibration, by metal objects, or by water getting inside the unit.

## **⚠ CAUTION**

**Failure to avoid the following potentially hazardous situations may result in injury or property damage.**

The navigation system is designed to provide you with route suggestions. It does not reflect road closures or road conditions, weather conditions, or other factors that may affect safety or timing while driving.

Use the navigation system only as a navigational aid. Do not attempt to use the navigation system for any purpose requiring precise measurement of direction, distance, location, or topography.

The Global Positioning System (GPS) is operated by the United States government, which is solely responsible for its accuracy and maintenance. The government system is subject to changes that could affect the accuracy and performance of all GPS equipment, including the navigation system. Although the navigation system is a precision navigation device, any navigation device can be misused or misinterpreted and, therefore, become unsafe.

## **📄 IMPORTANT INFORMATION**

### ***Vehicle Battery Preservation***

This navigation system can be used when the ignition key is turned to ON or ACC. To preserve the battery, however, it should be used with the engine running whenever possible. Using the navigation system for a long time with the engine switched off can cause the battery to run down.

### ***Map Data Information***

One of the goals of Garmin is to provide customers with the most complete and accurate cartography that is available to us at a reasonable cost. We use a combination of governmental and private data sources, which we identify in product literature and copyright messages displayed to the consumer. Virtually all data sources contain some inaccurate or incomplete data. In some countries, complete and accurate map information is either not available or is prohibitively expensive.

## **How to read this manual**

- The screens and panels shown in this manual are examples used to provide clear explanations of the operations. For this reason, they may be different from the actual screens or panels used, or some display patterns may be different.
- **Display language:** English is used for the purpose of explanation. You can select a display language from the **SETUP** menu. See **User Interface Setup (P.76)**.

# Basic Operations

## Functions of the Buttons on the Front Panel

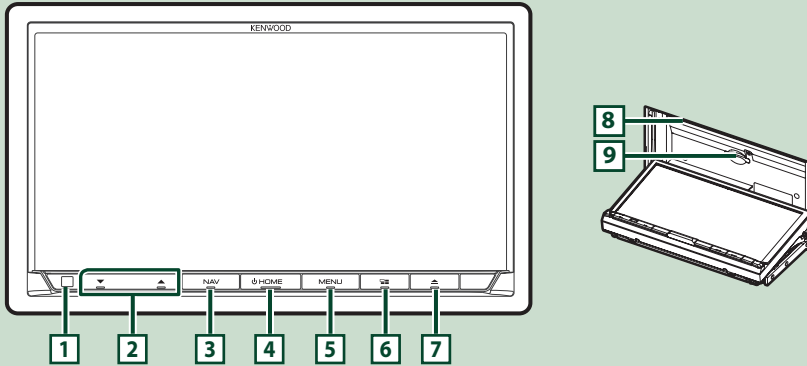

### NOTE

- The panels shown in this guide are examples used to provide a clear explanation of operations. For this reason, they may be different from the actual panels.

Number	Name	Motion
1	Remote Sensor	<ul style="list-style-type: none"> <li>Receives the remote control signal.</li> </ul>
2	▼, ▲ (Volume)	<ul style="list-style-type: none"> <li>Adjusts the volume.</li> <li>The volume will go up to 15 when you keep pressing ▲.</li> </ul>
3	NAV	<ul style="list-style-type: none"> <li>Displays the navigation screen.</li> </ul>
4	HOME	<ul style="list-style-type: none"> <li>Displays the HOME screen (P.11).</li> <li>Pressing for 1 second turns the power off.</li> <li>When the power is off, turns the power on.</li> </ul>
5	MENU	<ul style="list-style-type: none"> <li>Displays the popup menu screen.</li> <li>Pressing for 1 second switches view camera display on/off. (P.71)               <ul style="list-style-type: none"> <li>The camera whose view is displayed first changes according to the "Camera Setup" setting and the shift lever position in the shift gate.</li> </ul> </li> </ul>
6	☰	<ul style="list-style-type: none"> <li>Displays the APP (CarPlay/ Android Auto/ WebLink) screen.</li> <li>Pressing for 1 second displays the Voice Recognition screen (P.67).</li> </ul>
7	▲	<ul style="list-style-type: none"> <li>Displays the Angle Adjust screen.               <ul style="list-style-type: none"> <li><b>DISC EJECT</b>: Ejects the disc.</li> <li><b>OPEN</b>: Fully opens the panel to the location of the SD card slot.</li> </ul> </li> <li>When the panel is opened, pressing closes the panel.</li> <li>To forcibly eject the disc, press it for 2 seconds and then touch <b>DISC EJECT</b> after the message is displayed.</li> </ul>
8	Disc insert slot	<ul style="list-style-type: none"> <li>A slot to insert a disc media.</li> </ul>

Number	Name	Motion
9	SD card slot	<ul style="list-style-type: none"><li>• A slot to insert an SD card.</li><li>• You can play audio/visual files in the card. *</li><li>• An SD card slot for upgrading the map. For how to upgrade the map, refer to the instruction manual of the navigation system.</li></ul> <p>* If the map update file remains in the SD card, you cannot play audio/visual files. * Do not pull out the MAP SD while "Loading Maps" is being displayed.</p>

## Turning on the Unit

The method of turning on is different depending on the model.

- 1 Press the **HOME** button.

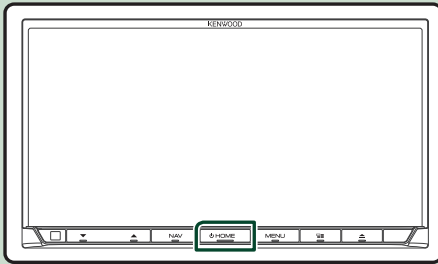

➤ The unit is turned on.

- **To turn off the unit:**

- 1 Press the **HOME** button for 1 second.

### NOTE

- If it is your first time to turn the unit on after installation, it will be necessary to perform Initial setup (**P.9**).

## Initial Settings

### Initial setup

Perform this setup when you use this unit first time.

#### 1 Set each item as follows.

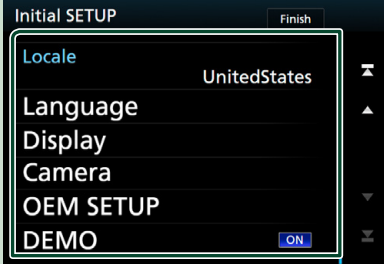

#### ■ Locale

Select the country for the navigation system. The language, the distance unit, and the gasoline unit are set.

- ① Touch **Locale**.
- ② Select the desired country.

#### ■ Language

Select the language used for the control screen and setting items. Default is "American English (en)".



- ① Touch **Language**.
- ② Touch **Language Select**.
- ③ Select the desired language.
- ④ Touch .

For details of operation, see **User Interface Setup (P.76)**.

#### ■ Display

Set the button illumination color.

If it is hard to see the image on the screen even, adjust the viewing angle.

- ① Touch **Display**.
- ② Touch **Key Color**.
- ③ Select the desired color.
- ④ Touch .
- ⑤ Touch **Viewing Angle**.
- ⑥ Select an angle
- ⑦ Touch .

For details of, see **Display Setup (P.78)**.

#### ■ Camera

Set the parameters for the camera.

- ① Touch **Camera**.
- ② Set each item and touch .

For details of, see **Camera Setup (P.71)**.

#### ■ OEM SETUP

This function requires a commercial adaptor. Consult your KENWOOD dealer for details.

#### ■ DEMO

Set the demonstration mode. Default is "ON".

- ① Touch **DEMO** and select ON or OFF.

#### 2 Touch Finish.

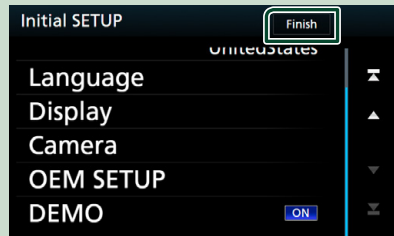

#### NOTE

- These settings can be made from the SETUP menu. See **Setup (P.75)**.

## Calendar/clock settings

- 1 Press the **MENU** button.  
➤ Popup menu appears.

- 2 Touch **SETUP**.



- SETUP Menu screen appears.

- 3 Touch **User Interface**.

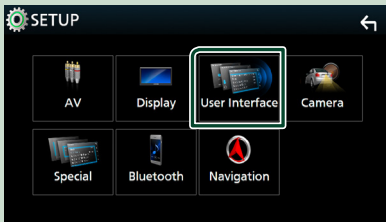

- User Interface screen appears.

- 4 Set each item as follows.  
Scroll the page to show hidden items.



### ■ Time Format

Select the time display format.

**12-Hour** (Default)/ **24-Hour**

### ■ Clock

**NAV-SYNC** (Default): Synchronizes the clock time with navigation GPS data.

**Manual**: Set the clock manually.

### ■ Time Zone

If you have selected **Manual** for Clock, select the time zone.

### ■ Clock Adjust

If you select **Manual** for Clock, adjust the date and time manually. (P.77)

## NOTE

- Please set the date and time. If they not set, some functions may not work.

## Adjusting the volume

To adjust the volume (0 to 40),

Press **▲** to increase, and press **▼** to decrease.

Holding **▲** increases the volume continuously to level 15.



## Monitor Angle Control

You can adjust the position of the monitor.

- 1 Press the **▲** button.

- Angle Adjust screen appears.

- 2 Select a number below that represents your desired angle setting.

Default is "0".



### ■ Off Position

You can store the current monitor angle as the angle during power off. Touch **Memory** when the desired angle is selected.

## Touch screen operations

To perform operations on the screen, you need to touch, touch and hold, flick or swipe to select an item, display a setting menu screen or change pages.

### ● Touch

Touch the screen gently to select an item on the screen.

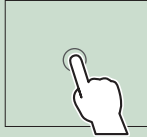

### ● Touch and hold

Touch the screen and keep your finger in place until the display changes or a message is displayed.

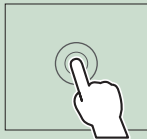

### ● Flick

Slide your finger quickly to the left or right on the screen to change the page. You can scroll a list screen by flicking up/ down on the screen.

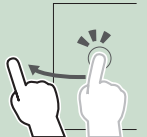

### ● Swipe

Slide your finger up or down on the screen to scroll the screen.



## HOME screen descriptions

Most functions can be performed from the HOME screen.



- |   |   |
|---|---|
| 1 | <ul style="list-style-type: none"> <li>Widget (<b>P.20</b>)               <ul style="list-style-type: none"> <li>– You can change the widget by flicking left or right on the widget area.</li> <li>– Touch the widget to display the detailed screen.</li> </ul> </li> </ul> |
| 2 | <ul style="list-style-type: none"> <li>Current source information</li> </ul>  |
| 3 | <ul style="list-style-type: none"> <li>Displays the control screen of the current source.</li> <li>The artwork is displayed if available from current content.</li> </ul>   |
| 4 | <ul style="list-style-type: none"> <li>Current source information</li> </ul>  |
| 5 | <ul style="list-style-type: none"> <li>Displays the source selection screen. (<b>P.12</b>)</li> </ul>   |
| 6 | <ul style="list-style-type: none"> <li>Short-cut playback source icons (<b>P.13</b>)</li> </ul>   |

## Display the HOME screen

- 1 Press the **HOME** button.



- HOME screen appears.

## Popup menu

- 1 Press the **MENU** button.
  - Popup menu appears.
- 2 Touch to display the popup menu.



The contents of the menu are as follows.

	• Displays the Screen Adjustment screen. (P.75)
	• Turns the display off. (P.12)
	• Displays the view camera screen. (P.71)
	• Displays the SETUP Menu screen. (P.75)
	• Displays the Audio screen. (P.81)
	• Displays the control screen of current source. Icon feature differs depending on the source.
	• Close the popup menu.
<b>1</b>	• Short-cut buttons: The source changes to the one you have set with a short-cut. For the short-cut setting, refer to <b>Customize Short-cut buttons on HOME screen (P.14)</b> .

## Turn off the screen

- 1 Select **Display OFF** on the popup menu.

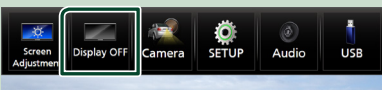

- To turn on the screen

- 1 Touch the display.

## Source selection screen description

You can display icons of all playback sources and options on the source selection screen.

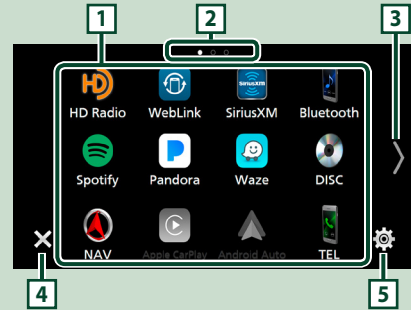















- 1 • Changes playback source. For playback sources, see **P.12**.
- 2 • Page indication
- 3 • Changes pages. (Touch **◀/▶**.) You can also change pages by flicking left or right on the screen.
- 4 • Returns to the previous screen.
- 5 • Displays the SETUP Menu screen. (P.75)

## Select the playback source

- 1 Press the **HOME** button.
  - HOME screen appears.
- 2 Touch .
  - From the screen, you can select the following sources and functions.

	• Displays the navigation screen. (P.16)
	• Switches to the Apple CarPlay screen from the connected iPhone. (P.28)
	• Switches to the Android Auto screen from the connected Android device. (P.29)

	• Displays the Hands Free screen. <b>(P.65)</b> When connecting as Apple CarPlay or Android Auto, it works as a phone provided in Apple CarPlay or Android Auto.
	• Switches to the HD Radio broadcast. <b>(P.42)</b>
	• Switches to the SiriusXM® satellite radio broadcast. <b>(P.48)</b>
	• Plays a Bluetooth audio player. <b>(P.60)</b>
	• Plays a disc. <b>(P.22)</b>
	• Plays an iPod/iPhone. <b>(P.39)</b>
	• Plays files on a USB device. <b>(P.36)</b>
	• Plays files on an SD card. <b>(P.36)</b>
	• Switches to Pandora. <b>(P.34)</b>
	• Switches to Spotify. <b>(P.32)</b>
	• Switches to an external component connected to the AV-IN input terminal. <b>(P.73)</b>
	• Displays the WebLink screen. <b>(P.31)</b>
	• Displays the Waze screen. <b>(P.31)</b>
	• Displays the Audio screen. <b>(P.81)</b>
	• Puts the unit in standby. <b>(P.13)</b>

- For sources and information displayed when an ADS adapter is connected, see **OEM Features Operation (P.74)**.

### To select the playback source on the HOME screen

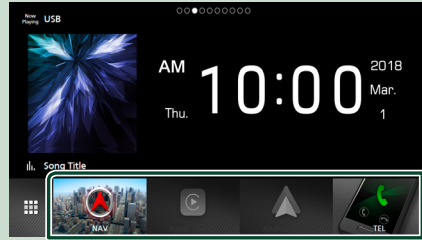



The 4 items displayed on the source selection screen with large icons are shown on the HOME screen.

You can change the items displayed on this area by customizing the source selection screen. **(P.14)**

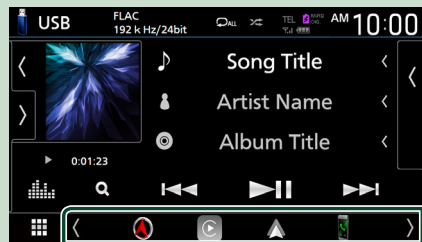
### To select the playback source on the source control screen



Display source selection buttons by touching  /  or flicking left or right on the source control screen, then select a playback source.

### Put the unit in standby

- 1 Press the **HOME** button.  
➤ HOME screen appears.
- 2 Touch .
- 3 Touch **STANDBY**.

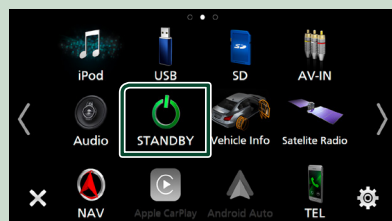

## Customize Short-cut buttons on HOME screen

You can arrange the positions of the source icons as you like.

- 1 Press the **HOME** button.
  - ▶ HOME screen appears.
- 2 Touch .
- 3 Touch and hold the icon which you want to move in the customizing mode.
- 4 Drag the icon to the desired position.

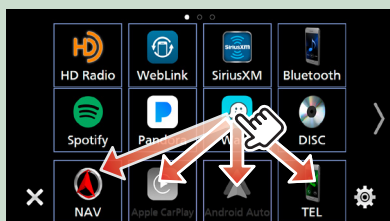

Changes the page



## Source control screen descriptions

There are some functions which can be performed from most screens.

Indicators



Navigation information

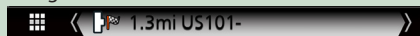

Short-cut buttons



### 1 All sources icon

Displays all sources.

### 2 Secondary screen

- : The Secondary screen changes to another one every time you touch it. You can also change the Secondary screen by flicking left or right on the screen.
- Indicators: Displays the current source condition and so on.
  - **ATT**: The attenuator is active.
  - **DUAL**: The dual zone function is active.
  - **MUTE**: The mute function is active.
  - **LOUD**: The loudness control function is active.
- Navigation information: Displays the current location and the direction. The screen changes to the navigation screen when you touch here.
- Short-cut buttons: The source changes to the one you have set with a short-cut. For the short-cut setting, refer to **Customize Short-cut buttons on HOME screen (P.14)**.

### 3 Content list

Displays the track/file/station/channel list.



- Connected Bluetooth device information.
- **RAPID CHG.**: Lights up during quick charging of the battery of the connected iPod/ iPhone/ Smartphone.

## 5 Artwork & information

You can select whether to display an artwork and song information or only song information in more detail.

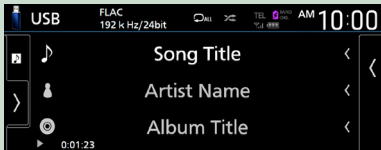
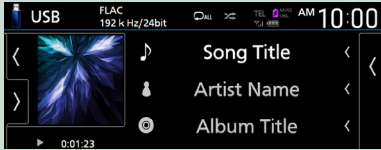

## 6 Function panel

Touch the left side of the screen to display the function panel. Touch again to close the panel.

## List screen

There are some common function keys in the list screens of most sources.



1

Displays the list type selection window.

2

Displays a music/movie file list.

3

Scrolls the displayed text.

4

**Play etc.**

Keys with various functions are displayed here.

- **Play**: Plays all tracks in the folder containing the current track.
- **A-Z**: Jumps to the letter you entered (alphabetical search).
- **Top** **Up**: Moves to the upper hierarchy level.

5

**Page scroll**

You can change pages to display more items by pressing **Up** / **Down**.

- **Top** / **Bottom**: Displays the top or bottom page.

6

**Return**

Returns to the previous screen.

### NOTE

- Buttons which cannot be activated from the list screen are not displayed.

## Navigation Operation

For details on the navigation function, please refer to the Navigation Instruction Manual.

### Display the navigation screen

- 1 Press the **NAV** button.



➤ The navigation screen appears.

- 2 Touch .

➤ Main Menu screen appears.

### How to Use the Navigation System

- 1 Operate the desired function from the Main Menu screen.

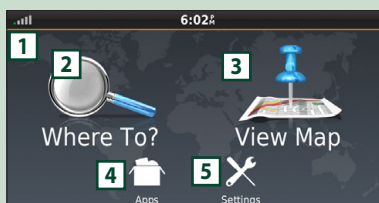

- |   |  |
|---|--|
| 1 | GPS satellite strength.                  |
| 2 | Finds a destination.                     |
| 3 | Views the map.                           |
| 4 | Uses the Apps such as ecoRoute and Help. |
| 5 | Adjusts the settings.                    |

#### NOTE

- You can get additional information about using the navigation system from Help. To display Help, touch **Apps** and then touch **Help**.

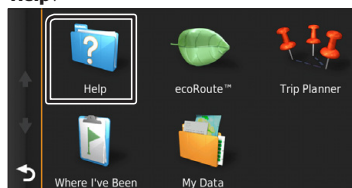

#### NOTE

- For more information about your navigation system, download the latest version of the Owner's Manual from <http://manual.kenwood.com/edition/im396/>

- 2 Enter your destination and start the guidance.

Finding points of interest

- ① Touch **Where To?**
- ② Select a category and a subcategory.
- ③ Select a destination.
- ④ Touch **Go!**

#### NOTE

- To enter letters contained in the name, touch the Search bar and enter the letters.

- 3 Follow your route to the destination.

#### NOTE

- The speed limit icon feature is for information only and does not replace the driver's responsibility to abide by all posted speed limit signs and to use safe driving judgment at all times. Garmin and JVC KENWOOD will not be responsible for any traffic fines or citations that you may receive for failing to follow all applicable traffic laws and signs.

Your route is marked with a magenta line. As you travel, your navigation system guides you to your destination with voice prompts, arrows on the map, and directions at the top of the map. If you depart from the original route, your navigation system recalculates the route.



- |   |   |
|---|---|
| 1 | Views the Next Turn page or the junction view page, when available. |
| 2 | Views the Turn List page.   |
| 3 | Views the Where Am I? page.   |
| 4 | Stops the current route.  |
| 5 | Displays traffic information on the route.                          |
| 6 | Returns to the Main menu.   |
| 7 | Displays a different data field.                                    |
| 8 | Views the Trip Computer.  |
| 9 | Displays more options.  |



#### NOTE

- Touch and drag the map to view a different area of the map.
- A speed limit icon could appear as you travel on major roadways.



### ● Adding a stop

- ① While navigating a route, touch  and then touch **Where To?**.
- ② Search for the extra stop.
- ③ Touch **Go!**.
- ④ Touch **Add to Active Route** to add this stop before your final destination.

### ● Taking a detour

- ① While navigating a route, touch .
- ② Touch .

### ■ Manually avoiding traffic on your route

- ① From the map, touch .
- ② Touch **Traffic On Route**.
- ③ If necessary, touch the arrows to view other traffic delays on your route.
- ④ Touch  > **Avoid**.

### ■ Viewing the traffic map

- ① The traffic map shows color-coded traffic flow and delays on nearby.

### ■ About traffic

- Traffic service is not available in some areas or countries.
- Garmin and JVC KENWOOD are not responsible for the accuracy or timeliness of the traffic information.
- You can receive INRIX traffic information and weather forecast by connecting your iPhone or Android smartphone in which the "KENWOOD Traffic Powered By INRIX" application is installed.  
For details, see "KENWOOD Traffic Powered By INRIX" application.

### ■ Updating maps



You can purchase updated map data from Garmin.

- ① Go to [www.garmin.com/kenwood](http://www.garmin.com/kenwood).
- ② From the Map Updates section, select Update
- ③ Follow the on-screen instructions.

## Control audio from the navigation screen

You can control audio sources while the navigation screen is displayed.

Also, you can view the navigation information while the source control screen is displayed. (P.14)

- 1 While playing the audio, touch  /  in the navigation screen.



Each time you touch the icon, the screen switches as follows.

Displays the navigation and control keys of the current source.

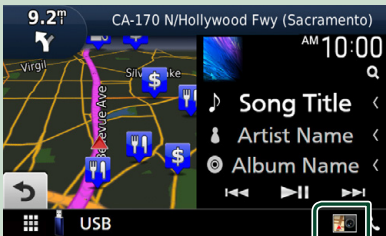

Displays the navigation and current video playback display.



Displays the navigation and view camera display.



Returns to the full navigation screen.

### NOTE

- For details on control keys, refer to the instructions in each section.
- Touching the source icon at the bottom of the screen displays the full audio screen. During video playback, touching the viewing area displays operation buttons.
- During camera view display, touching the viewing area switches between the front view camera/dashboard camera and the rear view camera.

## Navigation Setup

### 1 Press the **MENU** button.

- Popup menu appears.

### 2 Touch **SETUP**.

- SETUP Menu screen appears.

### 3 Touch **Navigation**.



- Navigation SETUP screen appears.

### 4 Set each item as follows.

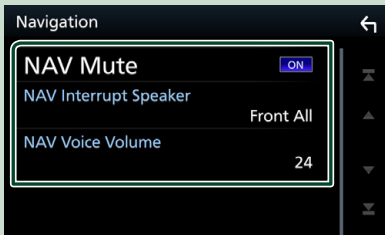

#### ■ **NAV Mute**

Mutes the volume of rear speakers during voice guidance of the navigation system. Default is "ON".

#### ■ **NAV Interrupt Speaker**

Selects speakers used for voice guidance of the navigation system.

- **Front L**: Uses the front left side speaker for voice guidance.
- **Front R**: Uses the front right side speaker for voice guidance.
- **Front All** (Default): Uses both front speakers for voice guidance.

#### ■ **NAV Voice Volume**

Adjusts the volume for voice guidance of the navigation system. Default is "24".

## KENWOOD Traffic Powered By INRIX

You can receive INRIX traffic information and weather forecast by connecting your iPhone or Android smartphone in which the "KENWOOD Traffic Powered By INRIX" application is installed to this unit.

### Preparation

- Install the latest version of the KENWOOD Traffic Powered By INRIX application on your iPhone or Android.
  - iPhone: Search for "KENWOOD Traffic Powered By INRIX" in the Apple App Store to find and install the most current version.
  - Android: Search for "KENWOOD Traffic Powered By INRIX" in Google play to find and install the most current version.
- For details, see "KENWOOD Traffic Powered By INRIX" application.

### 1 Register the Smartphone.

To connect a smartphone via Bluetooth, register it as the Bluetooth device and do the App (SPP) profile setting of the connection beforehand. See **Register the Bluetooth device (P.61)** and **Connect the Bluetooth device (P.62)**.

### 2 Press the **NAV** button.



- The navigation screen appears.

### 3 Touch .

- Main Menu screen appears.

Touch **Apps** on the Main Menu screen and then an icon of your desired content.

For details, see Navigation system manual.

# Widget

## Widget

- 1 Press the **HOME** button.
- 2 You can change the widget by flicking left or right on the widget area.



### Widget list

- NAV Widget
- Weather Widget \*1
- Clock Widget
- Compass Widget
- Spectrum analyzer Widget
- Tire Pressure Widget \*2
- Rader Widget \*2
- Climate Widget \*2
- Multi Widget \*3 (Spectrum analyzer, Clock, Current source information)
- Photo Frame Widget \*3

\*1 You can receive INRIX traffic information and weather forecast by connecting your iPhone or Android smartphone in which the "KENWOOD Traffic Powered By INRIX" application is installed.

\*2 This can be selected when a compatible ADS adapter is connected.

\*3 DNX995S only

## Weather Widget

You can display the weather forecast of the present location on the Home screen.

### Preparation

- See **KENWOOD Traffic Powered By INRIX (P.19)**.
- Select "ON" for Weather Widget. See **Widget Setup (P.21)**.

- 1 Press the **HOME** button.
- 2 Flick the widget area to the left/right to display the weather widget.



## Photo Frame Widget (DNX995S)

You can display a slideshow of the image files stored in the USB memory/ SD card on the Home screen.

### Preparation

- Select "ON" for Photo Frame Widget. See **Widget Setup (P.21)**.

### ● Acceptable Picture files

	Max. Picture size
JPEG (.jpg, .jpeg) *1	5,000 × 5,000
PNG (.png)	1,000 × 1,000
BMP (.bmp)	1,000 × 1,000

- This unit can only play back files which are less than 50 MB.
- The maximum number of files per device is 500.
- Picture files may not be played depending on their condition.

\*1 A progressive format is not supported.

## Photo Frame

- 1 Press the **HOME** button.
- 2 Flick the widget area to the left/right to display the photo frame widget.

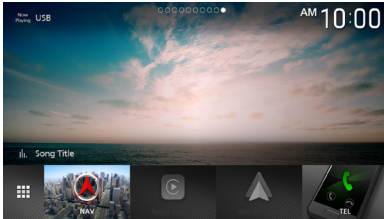

- Scroll the screen to display the hidden part.

## Widget Setup

Set up the widgets on the Home screen.

- 1 Press the **MENU** button.
  - Popup menu appears.
- 2 Touch **SETUP**.
  - SETUP screen appears.
- 3 Touch **User Interface**.



- User Interface screen appears.

- 4 Touch **Widget SETUP** in the User Interface screen.
- 5 Set each item as follows.
  - **Weather Widget**  
Determine whether to use the weather widget.  
"ON" (Default)/ "OFF"
  - **Photo Frame Widget (DNX995S)**  
Determine whether to use the photo frame widget.  
"ON" (Default)/ "OFF"
  - **Photo Frame SETUP (DNX995S)**  
Make settings related to display of the photo frame widget.

- 6 Touch  .

## To Photo Frame Setup (DNX995S)

Make settings related to display of the photo frame widget.

- 1 Touch **Photo Frame SETUP** on the Widget SETUP screen.
- 2 Set each item as follows.
  - **Sort Order**  
Specify a file sorting criterion.  
"By Name(Ascending)"/ "By Name(Descending)"/ "By Date(Newest First)" (Default)/ "By Date(Oldest First)"
  - **Slide Show Interval**  
Specify the slideshow interval.  
"5" (Default) to "30" seconds
  - **Photo Frame is •••••**  
Display help topics about the photo frame.
- 3 Touch  .

# Disc

## Playing a disc

### Insert a disc

- 1 Press the **▲** button.



- 2 Touch **DISC EJECT**.

► The panel opens.

- 3 Insert the disc into the slot.

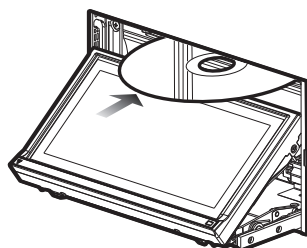

► The panel closes automatically.  
The unit loads the disc and playback starts.

### Eject a disc

- 1 Press the **▲** button.

- 2 Touch **DISC EJECT**.

When removing a disc, pull it horizontally.

- 3 Press the **▲** button.

## DVD/VCD Basic Operation

Most functions can be controlled from the source control screen and playback screen.

### NOTE

- Set the remote control mode switch to DVD mode before starting operation for DVD and VCD, see **Switch the operation mode (P.88)**.
- The screen shot below is for DVD. It may be different from the one for VCD.

- 1 When the operation buttons are not displayed on the screen, touch **[7]** area.

### Control screen

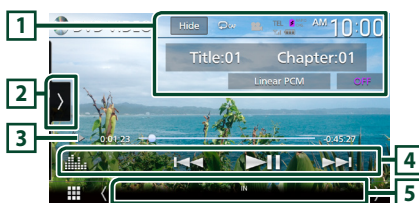







### Video screen



- 1 **Information display area**



Displays the following information.

- **Title #, Chapter #:** DVD title and chapter number
- **Track #/Scene #:** VCD track or scene number. Scene # is displayed only when Playback control (PBC) is on.











- **Linear PCM, etc.:** Audio format
- **OFF/Zoom2 – 4 (DVD)/ Zoom2 (VCD):**  
Displays the zoom ratio.
- **Hide:** Hides the control screen.
- : Repeats the current content. Each time you touch the key, repeat modes are switched in the following sequence;  
**DVD:** Title repeat (  ), Chapter repeat (  ), Repeat off (  )  
**VCD (PBC On):** Does not repeat  
**VCD (PBC Off):** Track repeat (  ), Repeat off (  )

## 2 Function panel

Touch the left side of the screen to display the function panel. Touch again to close the panel.





- : Stops playback. Touching twice will play the disc from the beginning when you play it next time.
-  : Fast-forwards or fast-backward the disc. Each time you touch the key, the speed changes. 2 times, 10 times.
-   (DVD only): Plays in slow motion forward or backward.
- **SETUP** (DVD only): Touch to display the DVD SETUP screen. See **DVD Setup (P.27)**.
- **MENU CTRL** (DVD only): Touch to display the DVD-VIDEO disc menu control screen. See **DVD Disc Menu Operation (P.26)**.
- **PBC** (VCD only): Touch to turn Playback control (PBC) on or off.
- **Audio** (VCD only): Touch to change audio output channels.

## 3 Play mode indicator/ Playing time

-   , etc.: Current play mode indicator  
Meanings of the icons are as follows:  (play),  (fast forward),  (fast backward),  (stop),  (resume stop),  (pause),  (slow playback),  (slow reverse playback).
- For confirmation of current playing position. You can drag the circle left or right to change the playing position.



## 4 Operation keys

-  : Searches for the previous/next content.
- Touch and hold to fast-forward or fast-backward the disc. (It will be cancelled automatically after about 50 seconds.)
- : Plays or pauses.
- : Displays the Graphic Equalizer screen. **(P.83)**

## 5 Indicator Items

- **IN:** Disc insertion status.  
White: A Disc is inside the unit.  
Orange: Disc player failure.

## VCD

- **1chLL/2chLL:** Identifies the left audio output of channel 1 or 2.
- **1chLR/2chLR:** Identifies the monaural audio output of channel 1 or 2.
- **1chRR/2chRR:** Identifies the right audio output of channel 1 or 2.
- **1chST/2chST:** Identifies the stereo audio output of channel 1 or 2.
- **LL:** Identifies the left audio output.
- **LR:** Identifies the monaural audio output.
- **RR:** Identifies the right audio output.
- **ST:** Identifies the stereo audio output.
- **PBC:** The PBC function is on.
- **VER1:** The VCD version is 1.
- **VER2:** The VCD version is 2.

## 6 Searching area

Touch to search for the next/previous content.

## 7 Key display area

Touch to display the control screen.

## 8 MENU CTRL (DVD only)

Touch to display the DVD-VIDEO disc menu control screen. See **DVD Disc Menu Operation (P.26)**.

## NOTE

- The control screen disappears when no operation is done for 5 seconds.
- If you use a remote control, you can jump directly to the desired image by entering the chapter number, scene number, play time, etc. **(P.88)**.

## Music CD/ Disc media Basic Operation

Most functions can be controlled from the source control screen and playback screen.

### NOTE

- Set the remote controller mode switch to AUD mode before starting operation for Music CD and audio files, see **Switch the operation mode (P.88)**.
- In this manual, "Music CD" means a general CD which includes music tracks.  
"Disc media" means a CD/DVD disc which includes audio or video files.
- The screen shot below is for disc media. It may be different from the one for CD.

### Control screen

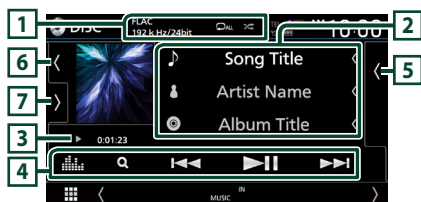

### Open the drawer



### Close the drawer

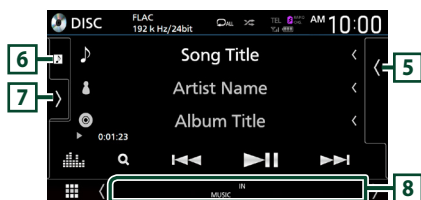

### 1 CODEC / [Repeat] / [Random]

- When a high-resolution source is played, its format information is displayed. (Disc media only)
- [Repeat]: Repeats the current track/folder. Each time you touch the key, repeat mode switches in the following sequence;

Track/ File repeat ([Repeat]), Folder repeat ([Folder Repeat]) (Disc media only), Repeat all ([Repeat All])

- [Random]: Randomly plays all tracks in current folder/disc. Each time you touch the key, random mode switches in the following sequence;  
Track random ([Track Random]) (Music CD only), Folder random ([Folder Random]) (Disc media only), Random off ([Random Off])

### 2 Track information

Displays the information of the current track/ file. Only a file name and a folder name are displayed if there is no tag information. (Disc media only)

### 3 Play mode indicator/ Playing time

- [Play], [Fast Forward], etc.: Current play mode indicator  
Meanings of the icons are as follows: [Play] (play), [Fast Forward] (fast forward), [Fast Backward] (fast backward), [Pause] (pause).
- For confirmation of current playing position. You can drag the circle left or right to change the playing position. (Video file only)



### 4 Operation keys

- [Search] (Disc media only): Searches files. For details on search operation, see **File search Operation (P.25)**.
- [Previous/Next]: Searches for the previous/next content.
- Touch and hold to fast-forward or fast-backward the disc. (It will be cancelled automatically after about 50 seconds.)
- [Play/Pause]: Plays or pauses.
- [Equalizer]: Displays the Graphic Equalizer screen. (P.83)

### 5 Content list

- Touch the right side of the screen to display the Content list. Touch again to close the list.
- Displays the playing list. When you touch a track/file name on the list, playback will start.

### 6 Artwork

- Displays/hides artwork area.
- The jacket of the currently playing file is displayed. (Disc media only)

### 7 Function panel (Disc media only)

Touch the left side of the screen to display the function panel. Touch again to close the panel.

-   : Searches for the previous/next folder.

### 8 Indicator Items

- **IN** : Disc insertion status.  
White: A Disc is inside the unit.  
Orange: Disc player failure.
- **VIDEO** : Identifies the video file.
- **MUSIC** : Identifies the music file.

Video screen



### 9 File search area (Video file only)

Touch to search for the next/previous file.

### 10 Key display area (Video file only)

Touch to display the control screen.

## File search Operation (Disc media only)

You can search for a file according to hierarchy.

### NOTE

- For operations in the list screen, see **List screen (P.15)**.

- 1 Touch  .  
➤ Folder List screen appears.

- 2 Touch the desired folder.

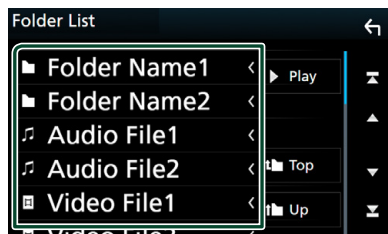

- When you touch a folder its contents are displayed.

- 3 Touch the desired item in the content list.  
➤ Playback starts.

## DVD Disc Menu Operation

You can set up some functions using the DVD-VIDEO disc menu.

### 1 Touch the framed area during playback.



➤ Menu Control screen appears.

### 2 Perform your desired operation as follows.

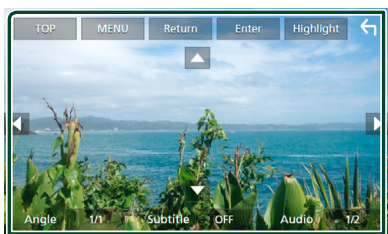

#### ■ To display the top menu

Touch **TOP**.\*

#### ■ To display the menu

Touch **MENU**.\*

#### ■ To display the previous menu

Touch **Return**.\*

#### ■ To enter selected item

Touch **Enter**.

#### ■ To enable direct operation

Touch **Highlight** to enter the highlight control mode (*P.26*).

#### ■ To move the cursor

Touch ▲, ▼, ◀, ▶.

#### ■ To switch among subtitle languages

Touch **Subtitle**. Each time you touch this key, subtitle languages are switched.

#### ■ To switch among audio languages

Touch **Audio**. Each time you touch this key, audio languages are switched.

#### ■ To switch among picture angles

Touch **Angle**. Each time you touch this key, picture angles are switched.

\*These keys may not function depending on the disc.

## Highlight control

Highlight control lets you control the DVD menu by touching the menu key directly on the screen.

### 1 Touch **Highlight** on the Menu Control screen.

### 2 Touch your desired item on the screen.



#### NOTE

- The highlight control function is cancelled automatically if you do not operate for a predetermined period of time.

## DVD Setup

You can set up the DVD playback functions.

### 1 Touch the framed area during playback.

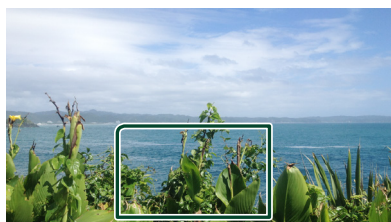

### 2 Touch on the left side of the screen. Touch **SETUP**.

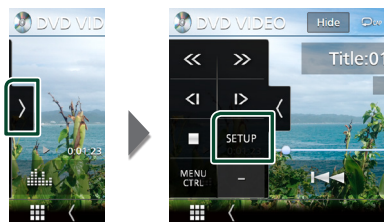

► DVD SETUP screen appears.

### 3 Set each function as follows.

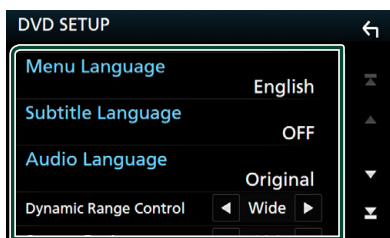

#### ■ **Menu Language / Subtitle Language / Audio Language**

See **Language setup (P.27)**.

#### ■ **Dynamic Range Control**

Sets the dynamic range.

**Wide:** The dynamic range is wide.

**Normal:** The dynamic range is normal.

**Dialog** (Default): Makes the total sound volume larger than the volumes in other modes. This is effective only when the Dolby Digital software is in use.

#### ■ **Screen Ratio**

Sets the screen display mode.

**16:9** (Default): Displays wide pictures.

**4:3 LB:** Displays wide pictures in the Letter Box format (having black stripes at the top and bottom of screen).

**4:3 PS:** Displays wide pictures in the Pan & Scan format (showing pictures cut at the right and left ends).

#### ■ **Language setup**

This setting is for the languages used for the menu, subtitle, and voice.

### 1 Touch the desired item; **Menu Language, Subtitle Language, Audio Language.**

► Language Set screen appears.

### 2 Select a language.

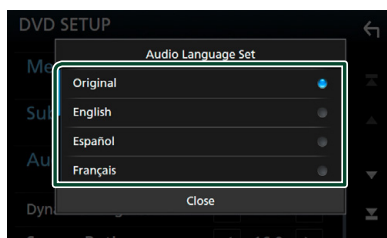

For language codes, refer to **DVD Language Codes (P.104)**.

Touch Close to set the entered language and return to the DVD SETUP screen.

#### NOTE

- To set the DVD's original language as the audio language, touch **Original**.

# APPS—Android Auto™/Apple CarPlay

## Apple CarPlay Operation

CarPlay is a smarter, safer way to use your iPhone in the car. CarPlay takes the things you want to do with iPhone while driving and displays them on the screen of the product. You can get directions, make calls, send and receive messages, and listen to the music from iPhone while driving. You can also use Siri voice control to make it easier to operate iPhone.

For details about CarPlay, visit <https://ssl.apple.com/ios/carplay/>.

### Compatible iPhone devices

You can use CarPlay with the following iPhone models.

- iPhone 7 Plus
- iPhone 6 Plus
- iPhone 7
- iPhone 6
- iPhone SE
- iPhone 5s
- iPhone 6s Plus
- iPhone 5c
- iPhone 6s
- iPhone 5

## Connecting an iPhone

### 1 Connect your iPhone using KCA-iP103 via the USB (Black) terminal. (P.98)

When an iPhone compatible with CarPlay is connected to the USB (Black) terminal, the Bluetooth Hands-Free phone currently connected is disconnected.

### 2 Unlock your iPhone.

#### ● Switching the Current Source to the Apple CarPlay Source When Connecting Your iPhone

When the iPhone you used previously is connected again, a confirmation message appears to ask whether you are sure to start the CarPlay source.

### 1 Connect iPhone using KCA-iP103 via USB (Black) terminal.

### 2 Unlock your iPhone.

### 3 Touch the connection message at the bottom of the screen.

The current source is connected to the CarPlay source.

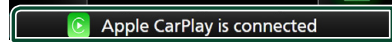

The connection message is displayed for about 5 seconds.

#### NOTE

- If the message disappears, select the CarPlay source on the source selection screen. (P.12)

## Operation buttons and available Apps on the home screen of CarPlay

You can use the Apps of the connected iPhone. The items displayed and the language used on the screen differ among the connected devices.

To enter the CarPlay mode, touch **Apple CarPlay** icon on the source selection screen. (P.12)

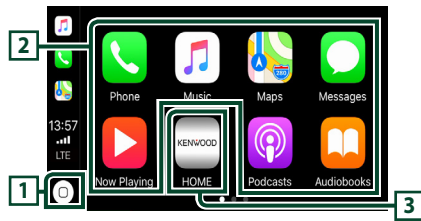

- Displays the home screen of CarPlay.
- Touch and hold to activate Siri.

### 2 Application buttons

Starts the application.

### 3 HOME

Exits the CarPlay screen and displays the Home screen.

### To exit the CarPlay screen

#### 1 Press the HOME button.

## Use Siri

You can activate Siri.

- 1 Press the  button for 1 second.

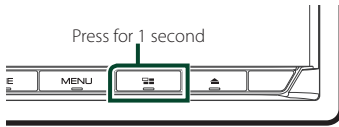

- 2 Talk to Siri.

### To deactivate

- 1 Press the  button.

## Switch to the Apple CarPlay screen while listening to another source

- 1 Press the  button.



### NOTE

- When listening to another source with the Apple CarPlay screen displayed, playing music in the Apple CarPlay mode will switch the current source to the Apple CarPlay source.

## Android Auto™ Operation

Android Auto enables you to use the functions of your Android device convenient for driving. You can easily access route guidance, make calls, listen to music, and access convenient functions on the Android device while driving. For details about Android Auto, visit <https://www.android.com/auto/> and <https://support.google.com/androidauto>.

### Compatible Android devices

You can use Android Auto with Android devices of Android version 5.0 (Lollipop) or later.

For Wi-Fi connection, Android 8.0 (Oreo) or later.

### NOTE

- Android Auto may not be available on all devices and may not be available in all countries or regions.

## Connect Android device

### Wired connection

- 1 **Connect an Android device via the USB terminal. (P.98)**  
To use the hands-free function, connect the Android device via Bluetooth.  
When an Android device compatible with Android Auto is connected to the USB terminal, the device is connected via Bluetooth automatically, and the Bluetooth Hands-Free phone currently connected is disconnected.
- 2 **Unlock your Android device.**
- 3 **Press the HOME button.**
- 4 **Touch .**
- 5 **Touch Android Auto. (P.12)**

### Wireless connection

When the Android device is ready for wireless connection, connecting it via the USB registers Bluetooth and Wi-Fi automatically. Thus, the registered Android device will be able to be connected wirelessly to be used as an Android Auto source.

- 1 Press the **HOME** button.
- 2 Touch .
- 3 Touch **Android Auto**. (P.12)

#### NOTE

- Turn on the Bluetooth function and Wi-Fi function of Android device.
- If two or more Android devices have been registered, select the Android device to be used as the Android Auto source. (P.30)

### Select an Android device

If two or more Android devices have been registered, select the Android device to be used as the Android Auto source.

- 1 Press the **HOME** button.
- 2 Touch .
- 3 Touch **Android Auto**. (P.12)
- 4 Select an Android device.

The registered Android devices ready for wireless connection and the Android device connected via the USB are displayed.

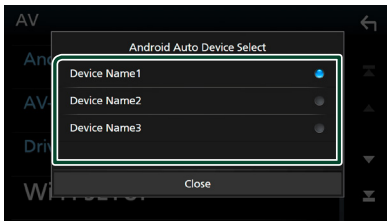

### Operation buttons and available Apps on the Android Auto screen

You can perform the operations of the Apps of the connected Android device. The items displayed on the screen differ

among the connected Android devices.

To enter the Android Auto mode, touch the **Android Auto** icon on the source selection screen. (P.12)

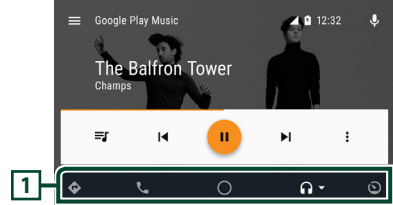

### 1 Application/information buttons

Starts the application or displays information.

### To exit the Android Auto screen

- 1 Press the **HOME** button.

### Using voice control

- 1 Press the  button for 1 second.

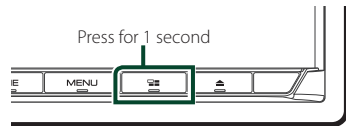

### To cancel

- 1 Press the  button.

### Switch to the Android Auto screen while listening to another source

- 1 Press the  button.



#### NOTE

- When listening to another source with the Android Auto screen displayed, playing music in the Android Auto mode will switch the current source to the Android Auto source.

## WebLink™/Waze Operation

You can display and control the App on the unit while your smartphone is connected to the USB terminal.

### Preparation

- Install the latest version of the WebLink application "WebLink for KENWOOD" on your iPhone or Android.
- iPhone:** Search for "WebLink for KENWOOD" in the Apple App Store to find and install the most current version.
- Android:** Search for "WebLink for KENWOOD" in Google play to find and install the most current version.

### Available Apps

You can use the following Apps on this unit. Install the Apps on your smartphone beforehand.

#### WebLink™

WebLink™ enables you to use the following Apps with the unit.

- Media player
- Waze
- Yelp
- YouTube
- Weather
- Next Radio

#### Waze

Waze is the world's largest community based traffic and navigation App. Join other drivers in your area who share real-time traffic and road info, saving everyone time and gas money on their daily commute.

- To use Waze on the unit, you need to install WebLink™ and Waze on your smartphone beforehand.

### Connect a smartphone

#### 1 Connecting a smartphone

- Connect an Android device via the USB terminal. **(P.98)**
- Connect your iPhone using KCA-iP103 via the USB (Black) terminal. **(P.98)**
- When your smartphone is connected to a unit, a confirmation message to communicate each other appears on the smartphone. Touch **Allow / OK** to establish connection, or **Ignore / Cancel** to cancel the connection.
- You can check the connection status on the WebLink™ screen on your smartphone.

#### 2 Press the **HOME** button.

#### 3 Touch .

#### 4 Touch **WebLink** or **Waze**. **(P.12)**

## Operation buttons and available Apps on the App screen

WebLink source screen

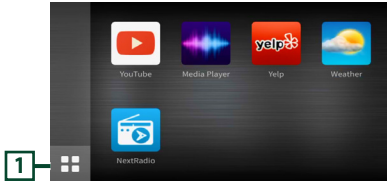

1  Displays the main menu of the “WebLink” source screen.



Returns to the previous screen.

### 1 Operate on your smartphone.

- When you are asked to communicate between your smartphone and the unit, touch **Allow** to proceed.

## Switching to the App screen while listening to another source

### 1 Press the button.

#### NOTE

- When listening to another source with the WebLink screen displayed, playing music in the WebLink mode will switch the current source to the WebLink source.

## Spotify Operation

You can listen to Spotify on this unit by controlling the application installed in the iPhone or Android.

To select the Spotify source, touch **Spotify** icon on the source selection screen. (P.12)

### Preparation

- Install the latest version of the Spotify application “Spotify” on your iPhone or Android.  
**iPhone:** Search for “Spotify” in the Apple App Store to find and install the most current version.  
**Android:** Search for “Spotify” in Google play to find and install the most current version.
- iPhones are connected via either USB or Bluetooth.
- Android devices are connected via Bluetooth.
- To connect a smartphone via Bluetooth, register it as the Bluetooth device and do the App (SPP) profile setting for the connection beforehand. See **Register the Bluetooth device (P.61)** and **Connect the Bluetooth device (P.62)**.

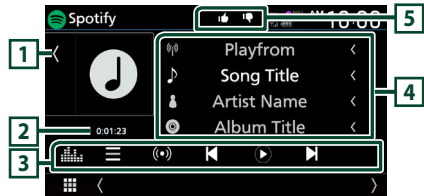

### Close the drawer

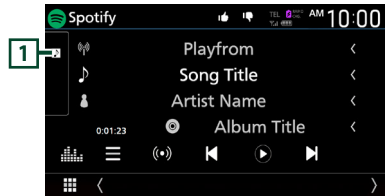









### 1 Artwork

- Displays/hides artwork area.
- Picture data is displayed if available from the current content.

### 2 Playing time

- For confirmation of play time.





### 3 Operation keys

-  : Displays the Menu screen
-  : New radio station that relates to the artist of the currently being played song is selected and playback starts.
-  ,  : Skips the current song.
-  ,  : Plays or pauses the content of the current station.
-  : Saves the currently being played song to My Music.
-  : Displays the Graphic Equalizer screen. (P.83)

### 4 Content information

Displays the information on the current content being played.



-  : Thumbs down to the current contents and skip to the next content.
-  : Registers the current content as a favorite content.
-  : Repeats the current song.
-  : Randomly plays all songs in the current playlist.

## ■ Selecting a track

1 Touch .

➤ Menu screen appears.

2 Select the list type, then select a desired item.

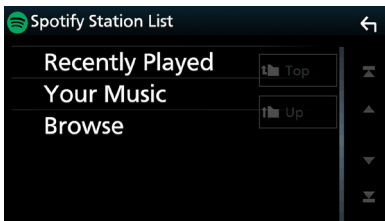

#### ■ To select the category and station

Touch the category and station name in the list.

#### ■ Top

Returns to the top of the list.

#### ■ Up

Returns to the previous list.

### About Spotify®

#### Note

- Ensure you are logged in to your smartphone application. If you do not have an Spotify account, you can create one for free from your smartphone or at [www.spotify.com](http://www.spotify.com).
- Because Spotify is a third-party service, the specifications are subject to change without prior notice. Accordingly, compatibility may be impaired or some or all of the services may become unavailable.
- Some functions of Spotify cannot be operated from this unit.
- For issues on using the application, contact Spotify at [www.spotify.com](http://www.spotify.com).
- Establish an Internet connection.

## Pandora® Operation

You can listen to Pandora® on this unit by controlling the application installed in the iPhone or Bluetooth device.

To select the Pandora source, touch the **Pandora** icon on the source selection screen. (P.12)

### Preparation

- Install the latest version of the Pandora® application on your iPhone, Android or BlackBerry.  
**iPhone:** Search for "Pandora" in the Apple App Store to find and install the most current version.  
**Android:** Visit the Google play and search for Pandora to install.  
**BlackBerry:** Visit www.pandora.com from the built in browser to download the Pandora application.
- iPhones are connected via either USB or Bluetooth.
- Android or BlackBerry devices are connected via Bluetooth.
- To connect a smartphone via Bluetooth, register it as the Bluetooth device and do the App (SPP) profile setting for the connection beforehand. See **Register the Bluetooth device (P.61)** and **Connect the Bluetooth device (P.62)**.

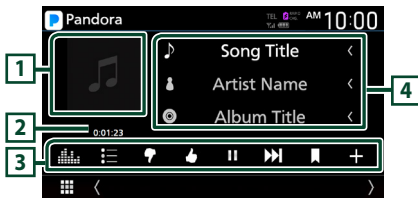

### 1 Artwork

Picture data is displayed if available from the current content.

### 2 Playing time

For confirmation of play time.

### 3 Operation keys

- : Searches for a station. For details on searching, see **Station list screen (P.34)**.
- (Thumbs down) : Thumbs down to the current contents and skips to the next contents.
- (Thumbs up) : Registers the current content as a favorite content.
- : Plays or pauses the content of the current station.

- : Skips the current song.  
 (Note that this function is disabled when the Pandora skip limitation is exceeded.)
- (Bookmark Song) : Bookmarks a song in the current contents.
- : Creates a new station. See **Creates a new station (P.35)**.
- : Displays the Graphic Equalizer screen. (P.83)

### 4 Content information

Displays the information on the current content being played.

## Station list screen

You can perform the following functions from this screen.

### 1 Touch .

> Station List screen appears.

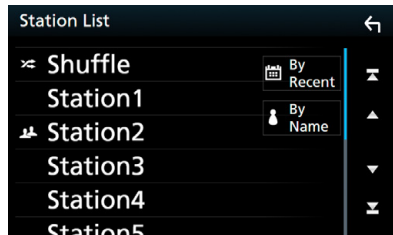

### ■ To select the station

Touch the station name in the list.

### ■ To sort the list by registered date

Touch **By Recent**. The list is sorted to begin with the last registered station.

### ■ To sort the list in alphabetical order

Touch **By Name**. You can select the desired letter from the list which corresponds to the station name to help narrow the search range.

### NOTE

- You can operate Pandora by using the remote control function. However, you can perform only play, pause, and skip operations.

## ■ Creates a new station

1 Touch **+** .

2 Touch your desired item.

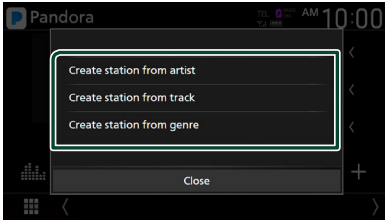

### ■ Create station from artist

Creates a new station based on the artist who is playing now.

### ■ Create station from track

Creates a new station based on the song being played.

### ■ Create station from genre

Displays the genre list screen.

## Genre list screen

1 Touch **Create station from genre** .

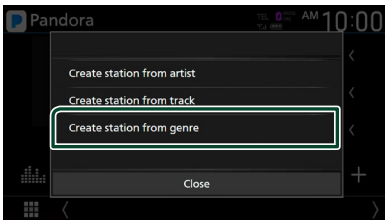

2 The selected genre is created as a new station.

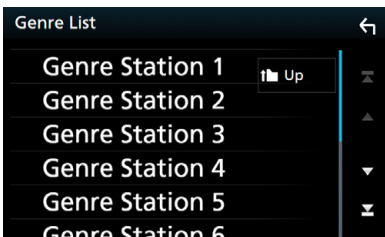

## About Pandora®

### NOTE

- In the application on your device, log in and create an account with Pandora. (If you are not already a registered user, an account can also be created at [www.pandora.com](http://www.pandora.com).)
- Establish an Internet connection.
- Pandora is only available in certain countries. Please visit <http://www.pandora.com/legal> for more information.
- Because Pandora® is a third-party service, the specifications are subject to change without prior notice. Accordingly, compatibility may be impaired or some or all of the services may become unavailable.
- Some functions of Pandora® cannot be operated from this unit.
- For issues on using the application, please contact Pandora® at [pandora-support@pandora.com](mailto:pandora-support@pandora.com).

## USB/SD

### Connecting a USB device

- 1 Connect the USB device with the USB cable. (P.97)

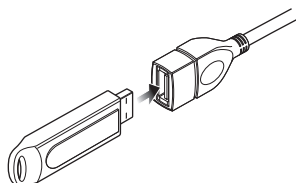

- 2 Press the **HOME** button.
- 3 Touch .
- 4 Touch **USB**. (P.12)

#### Disconnect the USB device

- 1 Press the **HOME** button.
- 2 Touch a source other than **USB**.
- 3 Detach the USB device.

#### Usable USB device

You can use a mass-storage-class USB device with this unit.

The word "USB device" appearing in this manual indicates a flash memory device.

#### ● About the file system

The file system should be the one of the following.

- FAT16
- FAT32
- exFAT
- NTFS

#### NOTE

- Install the USB device in the place where it will not affect safe driving.
- You cannot connect a USB device via a USB hub and Multi Card Reader.
- Take backups of the audio files used with this unit. The files can be erased depending on the operating conditions of the USB device. We shall have no compensation for any damage arising from any erased data.

### Inserting the SD

- 1 Press the **▲** button.

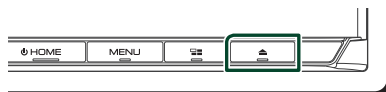

- 2 Touch **OPEN** to the panel fully opens.
- 3 Insert the SD card into the slot until it clicks.

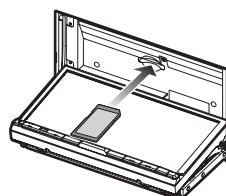

- 4 Press the **▲** button.
- 5 Press the **HOME** button.
- 6 Touch .
- 7 Touch **SD**. (P.12)

#### Remove the SD card

- 1 Press the **▲** button.
- 2 Touch **OPEN** to the panel fully opens.
- 3 Push the SD card until it clicks and then remove your finger from the card. The card pops up so that you can pull it out with your fingers.
- 4 Press the **▲** button.

#### Usable SD card.

The unit is capable of playback of SD/SDHC/SDXC memory cards complying with the SD, SDHC or SDXC standard. A special adapter is required to use a miniSD card, miniSDHC card, microSD card, microSDHC, or microSDXC card. The MultiMedia Card (MMC) cannot be used.

## USB/SD Basic Operation

Most functions can be controlled from the source control screen and playback screen.

### NOTE

- Set the remote controller mode switch to AUD mode before starting operation, see **Switch the operation mode (P.88)**.

### Control screen

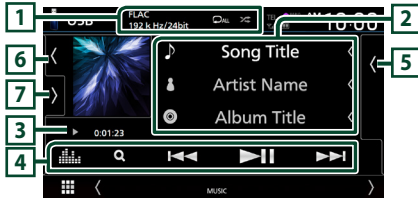



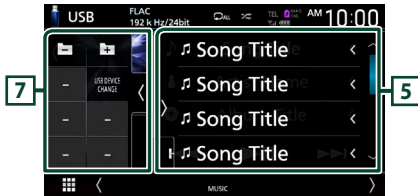

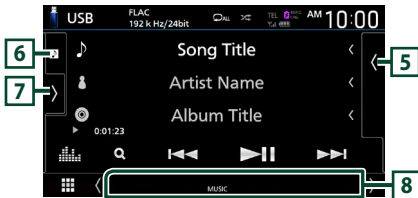

### Open the drawer



### Close the drawer



### 1 CODEC / /





- When a high-resolution source is played, its format information is displayed.
- : Repeats the current track/folder. Each time you touch the key, repeat modes are switched in the following sequence: File repeat () , Folder repeat () , Repeat all ()
- : Randomly plays all tracks in the current folder. Each time you touch the key, random modes are switched in the following sequence: File random () , Random off ()

### 2 Track information

Displays the information on the current file.





Only a file name and a folder name are displayed if there is no tag information.

### 3 Play mode indicator/ Playing time

- , etc.: Current play mode indicator. Meanings of individual icons are as follows:  (play),  (fast forward),  (fast backward),  (pause).
- For confirmation of current playing position. You can drag the circle left or right to change the playing position. (Video file only)



### 4 Operation keys

- : Searches track/file. For details on search operation, see **Search Operation (P.38)**.
-  : Searches the previous/next track/file. Touch and hold to fast forward or fast backward. (It will be cancelled automatically after about 50 seconds.)
- : Plays or pauses.
- : Displays the Graphic Equalizer screen. (P.83)

### 5 Content list



- Touch the right side of the screen to display the Content list. Touch again to close the list.
- Displays the playing list. When you touch a track/file name on the list, playback will start.

### 6 Artwork

- Displays/hides artwork area.
- The jacket of the currently playing file is displayed.

### 7 Function panel

Touch the left side of the screen to display the function panel. Touch again to close the panel.

-  : Searches for the previous/next folder.
- USB DEVICE CHANGE:** Switches to another USB device when two USB devices are connected.

### 8 Indicator Items

- VIDEO:** Identifies the video file.
- MUSIC:** Identifies the music file.

Video screen



**9 File search area (Video file only)**

Touch to search for the next/previous file.

**10 Key display area (Video file only)**

Touch to display the control screen.

## Search Operation

You can search music or video files by the following operations.

**1** Touch **Q**.

**2** Touch **▼**.



**3** Select a list type.

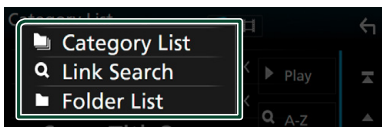

### NOTE

- For operations on the list screen, see **List screen (P.15)**.

## Category search

You can search for a file by selecting a category.

**1** Touch **Category List**.

**2** Select whether you search audio files or video files .

**3** Touch the desired category.

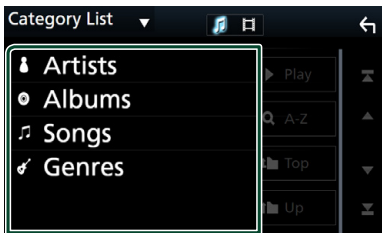

➤ The list corresponding to your selection appears.

**4** Touch to select the desired item in the list. Repeat this step until you find the desired file.

## Link search

You can search for a file of the same artist/album/genre as that in the current track.

- 1 Touch **Link Search**.
- 2 Touch the desired tag type. You can select from artists, albums and genres.

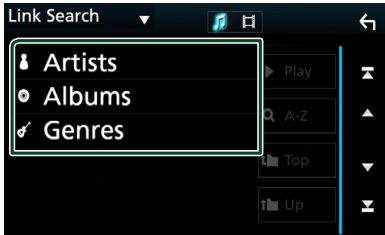

- ▶ The list corresponding to your selection appears.

- 3 Touch the desired item in the content list.

## Folder search

You can search for a file according to hierarchy.

- 1 Touch **Folder List**.
- 2 Touch the desired folder.

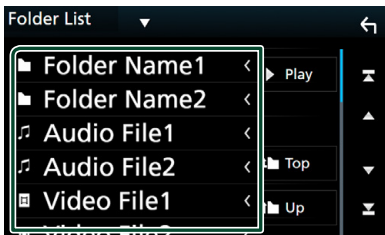

When you touch a folder its contents are displayed.

- 3 Touch to select your desired item in the list. Repeat this step until you find the desired file.

# iPod/iPhone

## Preparation

### Connectable iPod/iPhone

The following models can be connected to this unit.

Made for

- iPhone 7 Plus
- iPhone 7
- iPhone SE
- iPhone 6s Plus
- iPhone 6s
- iPhone 6 Plus
- iPhone 6
- iPhone 5s
- iPhone 5c
- iPhone 5
- iPod touch (6th generation)
- iPod touch (5th generation)

### NOTE

- Latest compatible list of iPod/iPhone. For details, see [www.kenwood.com/cs/ce/ipod/](http://www.kenwood.com/cs/ce/ipod/).
- By connecting your iPod/iPhone to this unit with the iPod connection cable KCA-iP103 (optional accessory), you can supply power to your iPod/iPhone as well as charge it while playing music. Note that the power of this unit must be held on.
- If you restart playback after connecting the iPod, the music that has been played by the iPod is played first.

### Connect iPod/iPhone

#### Wired connection

##### Preparation

- Connect an iPod/iPhone with the KCA-iP103 (optional accessory) while CarPlay is not connected.
- With a CarPlay-capable iPhone, turn off CarPlay by operating the iPhone at functional setup before connecting iPhone. For details of the setup method, contact the manufacturer of the terminal.
- Plug the iPod/iPhone into the gray USB terminal with the KCA-iP103 (optional accessory).
- Only one iPod/iPhone can be connected.

- 1 Connect the iPod/iPhone using the KCA-iP103. (P.98)
  - 2 Press the **HOME** button.
  - 3 Touch .
  - 4 Touch **iPod**. (P.12)
- To disconnect the iPod/iPhone connected with the cable:
    - 1 Detach the iPod/iPhone.

### Bluetooth connection

Pair the iPhone through Bluetooth.

#### Preparation

- To connect an iPhone via Bluetooth, register it as a Bluetooth device and do the profile setting for the connection beforehand. See **Register the Bluetooth device (P.61)** and **Connect the Bluetooth device (P.62)**.
- Connect an iPhone via Bluetooth while CarPlay and an iPod/iPhone are not connected via USB.

## iPod/iPhone Basic Operation

#### NOTE

- Set the remote controller mode switch to AUD mode before starting operation, see **Switch the operation mode (P.88)**.

#### Control screen

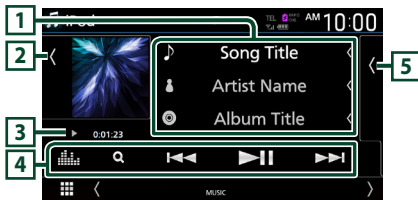

#### Open the drawer

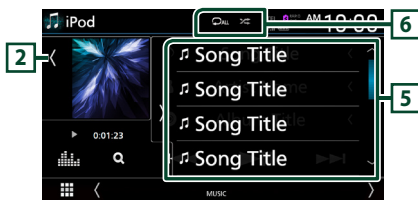

#### Close the drawer

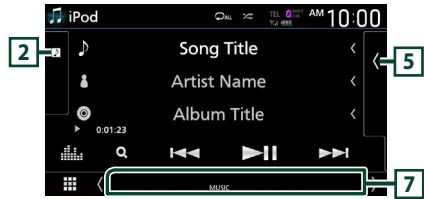

#### 1 Track information

- Displays the information on the current file.
- Touch to display the category list screen. See **Category search (P.41)**.

#### 2 Artwork

- Displays/hides artwork area.
- The jacket of the currently being played file is displayed.

#### 3 Play mode indicator/ Playing time

- : Current play mode indicator  
Meanings of individual icons are as follows:  
▶ (play), ▶▶ (fast forward), ◀◀ (fast backward), || (pause).

#### 4 Operation keys

- : Searches for a track/file. For details on search operation, see **Search Operation (P.41)**.
- : Searches for the previous/next track/file.  
Touch and hold to fast forward or fast backward. (It will be cancelled automatically after about 50 seconds.)
- : Plays or pauses.
- : Displays the Graphic Equalizer screen. (P.83)

#### 5 Content list

- Touch the right side of the screen to display the Content list. Touch again to close the list.
- Displays the playing list. When you touch a track/file name on the list, playback will start.

#### 6 Repeat/Random

- : Repeats the current track/album. Each time you touch the key, repeat modes are switched in the following sequence:  
Song repeat ( ), All songs repeat ( ), Repeat off ( )
- : Randomly plays all tracks in the current album. Each time you touch the key, random modes are switched in the following sequence:  
Song random ( ), Random off ( )

## 7 Indicator Items

- **MUSIC**: Identifies the music file.

## Search Operation

You can search music files by the following operations.

- 1 Touch **Q**.
- 2 Touch **▼**.



- 3 Select a list type.

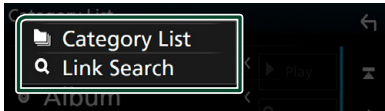

### NOTE

- For operations on the list screen, see **List screen (P.15)**.

## Category search

You can search for a file by selecting a category.

- 1 Touch **Category List**.
- 2 Touch the desired category.

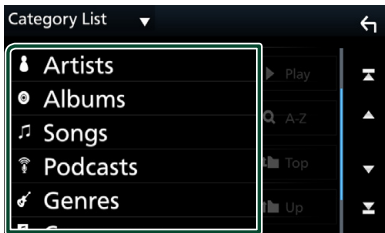

- The list corresponding to your selection appears.

- 3 Touch to select the desired item in the list. Repeat this step until you find the desired file.

## Link search

You can search for a file of the same artist/album/genre/composer as that in the current track.

- 1 Touch **Link Search**.
- 2 Touch the desired tag type. You can select from artists, albums, genres and composers.

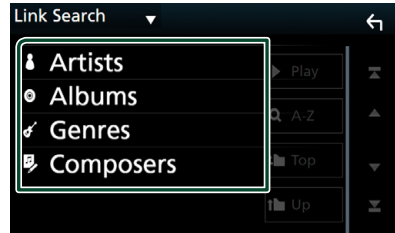

- The list corresponding to your selection appears.

- 3 Touch the desired item in the content list.

# HD Radio™ Tuner

## HD Radio Tuner Basic Operation

Most functions can be controlled from the source control screen.

To listen to the HD Radio source, touch **HD Radio** icon on the source selection screen. (P.12)

### NOTE

- Set the remote control mode switch to AUD mode before starting operation, see **Switch the operation mode (P.88)**.
- HD Radio broadcasting is for North American sales area only.
- The screen shot below is for tuner. It may be different from the one for HD Radio broadcasting.

Control screen



Open the drawer



Close the drawer



### 1 Information display

Displays the information on the current station: Frequency and Channel

Touching allows you to switch between Content A, Content B and Content C.

Content A: Station name, Song Title, Artist Name

Content B: Station Message, Radio Text

Content C: PTY Genre, Album Name

### 2 Seek mode

Touch to switch seek mode in the following sequence: **AUTO1**, **AUTO2**, **MANUAL**.

- **AUTO1** :Tunes in a station with good reception automatically.
- **AUTO2** :Tunes in the memorized stations one after another.
- **MANUAL** : Switches to the next frequency manually.

### 3 Picture

- Displays/hides picture area.
- The picture data or station Logo data is displayed if available from current content.

### 4 Function panel

Touch the left side of the screen to display the function panel. Touch again to close the panel.

- **10key Direct** : Display the direct station/channel search screen. For details, see **Direct search (P.45)**.

- **AME** : Presets stations automatically. For details, see **Auto memory (P.44)**.

- **RCV** : Change the HD Radio reception mode. For details, see **Receive Mode (P.44)**.

- **PTY** (FM only): Searches for a program by program type. For details, see **Search by program type (P.45)**.

- : Stores the information about the song being received. See **Bookmark (P.46)**.

- **Emergency Alerts** : Turn on or off the alert message. See **Alert Message (P.47)**.

- **Alert Message Log** : Displays the alert message received. See **Alert Message (P.47)**.

## 5 Operation keys

- **◀◀ ▶▶** : Tunes in a station. The method of switching frequencies can be changed (see **2** Seek mode).
- **CH▼ CH▲** : Selects a channel.
- **Q** : Display the Channel List screen. See **Channel search (P.45)**.
- **☰** : Display a list of registered bookmarks. See **Bookmark list (P.46)**.
- **📊** : Displays the Graphic Equalizer screen. **(P.83)**

## 6 Preset list

- Touching **⏪ / ⏩** allows you to change the display size.
- Recalls the memorized station or channel.
- When touched for 2 seconds, stores the currently being received station or channel in the memory.

## 7 Indicator display

While receiving an HD Radio station, it lights with orange when the audio is digital and lights with gray when it is analog. While receiving an analog station, it is off.

## 8 Band buttons

Switches bands (between FM and AM).

## 9 Indicator Items

- **MC**: A multicast digital broadcast is being received.
- **ANALOG**: An analog broadcast is being received.
- **DIGITAL**: A digital broadcast is being received.
- **ST**: A stereo broadcast is being received.
- **EA**:
  - White: Emergency Alert is on.
  - No light: Emergency Alert is off.
  - Orange: Interrupting or in snooze/ignore state.

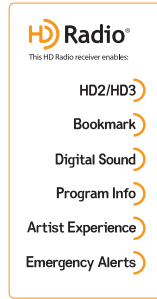

## HD2/HD3

- Adjacent to traditional main stations are HD2/HD3 Channels, providing new original programming on the FM dial

## Bookmark

- A music & product discovery feature that enables users to store information about content on the radio, and can deliver interactive information via QR codes

## Digital Sound

- Crystal clear, CD-like digital audio quality to consumers; eliminates background noise

## Program Info

- Provides song name, artist, station ID, and other relevant data to enrich the listening experience

## Artist Experience

- Visual images, such as album art of over-the-air broadcasts from HD Radio stations

## Emergency Alerts

- Delivers critical and life-saving messages to the public during emergency situations

## Receive Mode

You can set the radio broadcasts receive mode.

- 1 Touch  on the left side of the screen. Touch **RCV**.

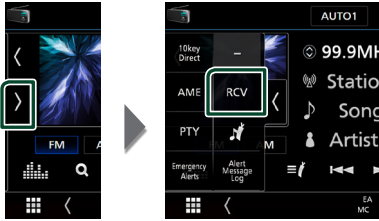

- 2 Select a receive mode.



### ■ Auto

Switch between digital and analog audio automatically.

### ■ Digital

Select this to tune to digital audio only.

### ■ Analog

Select this to tune to analog audio only.

## Memory Operation

### Auto memory

You can store stations with good reception in the memory automatically.

- 1 Touch desired band key.

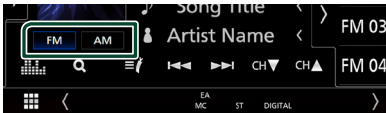

- 2 Touch  on the left side of the screen. Touch **AME**.

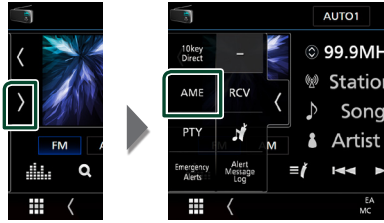

- 3 Touch **Yes**.

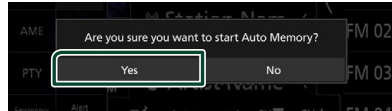

> Auto memory starts.

### Manual memory

You can store the currently being received station or channel in the memory.

- 1 Select the station or channel you wish to store in the memory.
- 2 Touch **FM#** (#:1-15) or **AM#** (#:1-5) in which you want to store the station or channel for 2 seconds until a beep sounds.

## Selecting Operation

### Preset select

You can list and select memorized stations or channels.

- 1 Touch  on the right side of the screen. Select a station or channel from the list.

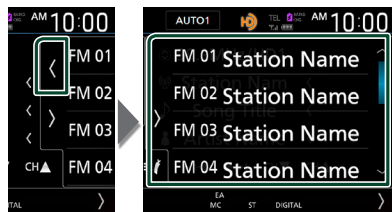

## Direct search

You can tune in by entering the desired frequency or channel number.

- 1 Touch **>** on the left side of the screen. Touch **10key Direct**.



- 2 Select the search method.

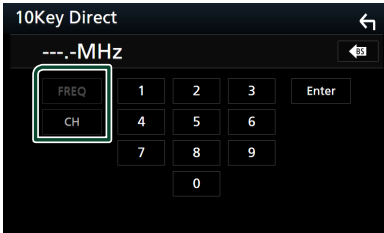

- 3 Enter the frequency or channel number.
- 4 Touch **Enter**.

### NOTE

- To clear the number you entered, touch **BS**.

## Channel search

You can specify the desired channel.

- 1 Touch **Q**.

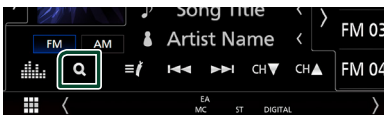

- 2 Select the desired content from the list.

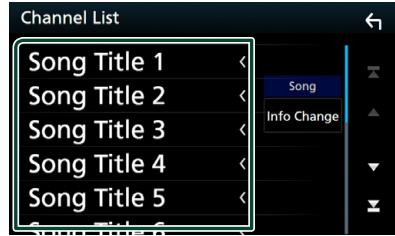

### NOTE

- Touch **Info Change** in the channel list. Select the sequence of the list (Song title, artist name, album name).

## Search by program type (FM only)

You can tune in the station broadcasting the specified type of program when listening to FM.

- 1 Touch **>** on the left side of the screen. Touch **PTY**.

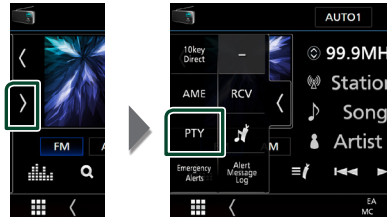

▶ TUNER PTY Mode screen appears.

- 2 Select a program type from the list.
- 3 Touch **Search**.

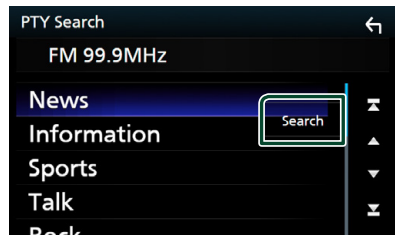

You can search for the station broadcasting the selected type of program.

## Bookmark

Stores tag information (title, artist, album, URL, and description) about the song you are listening to now.

Detailed information and QR codes can be displayed according to the stored tag information.

### Bookmark registration

- 1 Touch  on the left side of the screen.  
Touch .

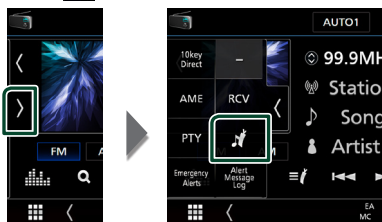

➤ Registers a bookmark.

#### NOTE

- Up to 100 bookmarks can be registered to this unit.

### Bookmark list

Displaying a list of registered bookmarks and detailed information and QR code of the song.

- 1 Touch .

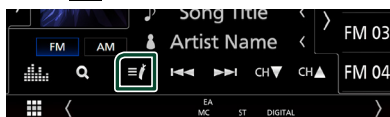

- 2 Select the desired bookmark from the list.

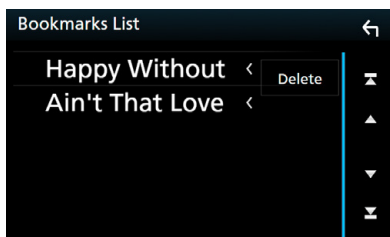

➤ The bookmark information appears.

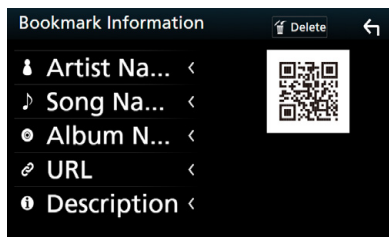

- 1  **Delete**

Deletes the bookmarks being displayed.

### Bookmark delete

Deleting a bookmark.

- 1 Touch **Delete**.

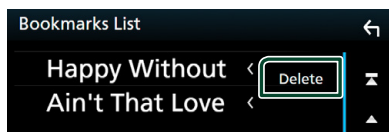

- 2 Select the bookmark to delete from the list.

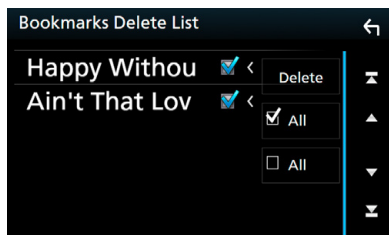

- 1  **All**  
Select all bookmarks.

- 1  **All**  
Erases all check marks.

- 3 Touch **Delete**.

➤ Confirmation message appears.

- 4 Touch **Yes**.

➤ Deletes all the selected bookmark(s).

## Alert Message

This function is to receive alert messages. First, you need to turn on the “Emergency Alerts”.  
(P.42)

### When an Alert Message comes



#### Snooze

The alert message is erased. Same alert message cannot be displayed for next 10 minutes.

#### Ignore

The alert message is erased. Same alert message cannot be displayed for next 12 hours.

#### Allow Alert

Touch to tune to that channel of HD Radio source.

### Display of the received Alert Message

You can read the received alert message afterward.

- 1 Touch  on the left side of the screen. Touch **Alert Message Log**.

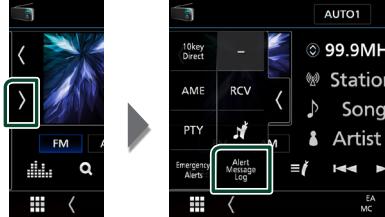

- 2 Select the desired Alert Message from the list.

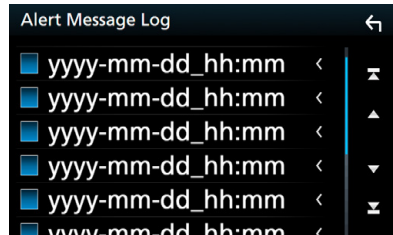

> The Alert Message appears.

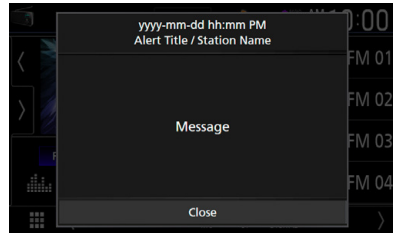

- 3 Touch **Close**.

# SiriusXM®

## SiriusXM® Basic Operation

Only SiriusXM® brings you more of what you love to listen to, all in one place. Get over 140 channels, including commercial-free music plus the best sports, news, talk, comedy and entertainment. Welcome to the world of satellite radio. A SiriusXM Vehicle Tuner and Subscription are required. For more information, visit [www.siriusxm.com](http://www.siriusxm.com).

To listen to the SiriusXM source, touch the **SiriusXM** icon on the source selection screen. (P.12)

### Activating subscription

- Check your Radio ID.
  - The SiriusXM Satellite Radio ID is required for activation and can be found by tuning in Channel 0 as well as on the label found on the SiriusXM Connect tuner and its package.
  - The Radio ID does not include the letters I, O, S or F.
- Activate the SiriusXM Connect Vehicle Tuner using either one of the two methods below:
  - For users in U.S.A.
    - Online: Visit [www.siriusxm.com/activatenow](http://www.siriusxm.com/activatenow)
    - Phone: Call SiriusXM Listener Care at 1-866-635-2349
  - For users in Canada:
    - Online: Visit <http://www.siriusxm.ca/help/activation-help/>
    - Phone: Call XM customer Care at 1-877-438-9677

### NOTE

- Set the remote control mode switch to AUD mode before starting operation, see **Switch the operation mode (P.88)**.
- To use SiriusXM® Satellite Radio, the optional accessory is necessary.

### Control screen



### Open the drawer

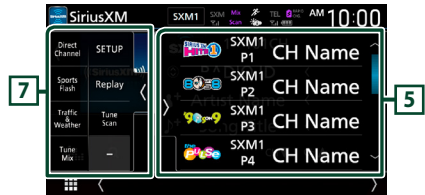

### Close the drawer

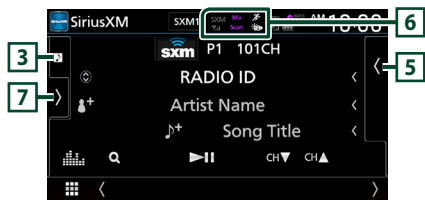

### 1 Information display

Displays the information on the current channel: Channel Name

**P#:** Preset number

**#CH:** Channel number

**Logo:** Channel logo

Touching  allows you to switch between Content A, Content B and Content C.

Content A: Artist Name, Song Title

Content B: Content Info, Category Name

Content C: Channel Description, Similar Channels

 : Touch for 2 seconds to register the artist of the current song as a Content Alert.

 : Touch for 2 seconds to register the current song as a Content Alert.

For details, see **Content Alerts (P.53)**.

## 2 Band button

Switches among bands. (SXM1/ SXM2/ SXM3/ SXM4)

## 3 Artwork

- Displays/hides artwork area.
- Displays the album artwork for most SiriusXM music channels



## 4 Operation keys

- **Q** : Display the Category search screen. For details on search operation, see **Category/ Channel search (P.51)**.
- **▶||** : Plays or pauses. See **Replay (P.51)**.
- **CH▼ CH▲** : Selects a channel.
- **EQ** : Displays the Graphic Equalizer screen. **(P.83)**

## 5 Preset list

- Touching **◀ / ▶** allows you to change the display size.
- Recalls the memorized channel.
- When touched for 2 seconds, stores the currently being received channel in the memory.

## 6 Indicator display

Displays the "Mix" (TuneMix™), "Scan" (TuneScan™),  (Traffic&Weather), or  (SportsFlash™) indicator and the received signal strength of the SiriusXM tuner.





## 7 Function panel

Touch the left side of the screen to display the function panel. Touch again to close the panel.

- **Direct Channel**: Touch and enter the desired number. For details, see **Direct search (P.50)**.
- **SETUP**: Touch to display the SiriusXM SETUP screen. For details, see **SiriusXM Setup (P.54)**.
- **Replay/ Live**: Touch to turn on or off the replay mode. See **Replay (P.51)**.
- **Traffic & Weather**



### For SXV300 \*1

Traffic & Weather Now™ allows you to access the latest report whenever you want to hear it. Select your city from the set up menu **Select a City for Traffic & Weather (P.59)** and press the **Traffic & Weather** button to check the latest report. It will start from the beginning.

-  (White) : Played already.
-  (Green) : New information has arrived.
-  (Purple) : Playing.
-  (Gray) : No information.

### For SXV200 or SXV100 \*2

Turns the Traffic & Weather Jump function on or off.

-  (White) : Function on.
-  (Purple) : Playing.
-  (Gray) : Function off.
- **TuneScan** \*3 : Allows you to hear a few seconds of songs from each of the SmartFavorite music channels on the current preset band. See **TuneScan™ (P.52)**.
- **TuneMix** \*4 : When turned ON, shuffles the preset channels on P1-P6 to play a blend of songs from your favorite channels. See **TuneMix™ (P.52)**.
- **SportsFlash** \*4 : Displays during SportsFlash™. Touch to cancel the SportsFlash™ function and return to the previous channel. See **SportsFlash™ (P.54)** and **SportsFlash™ setup (P.58)**.

\*1 Compatible with SXV300 or later tuner models. It may take a few minutes after power on to get the first full report on your city. Traffic channels are not available in Canada.

\*2 When SXV200 or SXV100 is connected with this unit.

\*3 Compatible with SXV200 or later tuner models.

\*4 Compatible with SXV300 or later tuner models.

## Storing Channels in Preset Memory

You can store the current channel in memory.

- 1 Tune in the channel you wish to store in the memory.
- 2 Touch **BS** on the right side of the screen.

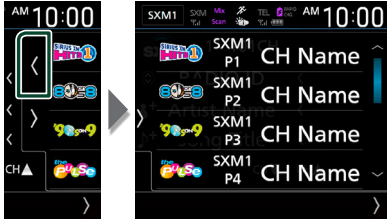

- 3 Touch **SXM(1-4) P(1-6)** in which you want to store the channel for 2 seconds until a beep sounds.

## Preset select

You can list and select memorized channels.

### To select from the preset list

- 1 Touch **BS** on the right side of the screen. Select a channel from the list.

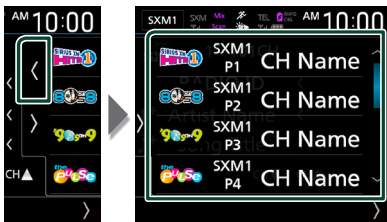

## Direct search

You can tune in a channel directly.

- 1 Touch **BS** on the left side of the screen. Touch **Direct Channel**.

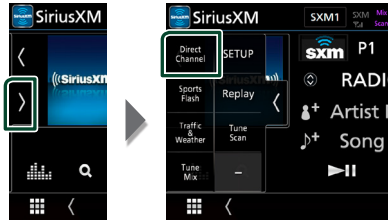

- 2 Enter the channel number and touch **Enter**.

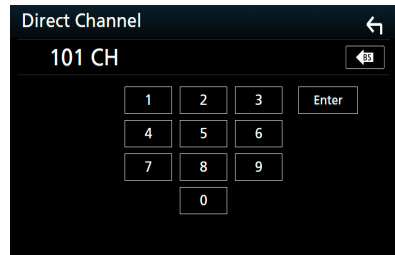

### NOTE

- To clear the number you entered, touch **BS**.

## Category/Channel search

You can specify the desired category and select a channel.

### 1 Touch **Q**.

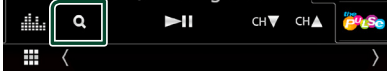

### 2 Select a category.



► Channel list appears.

### 3 Select the desired content from the list.

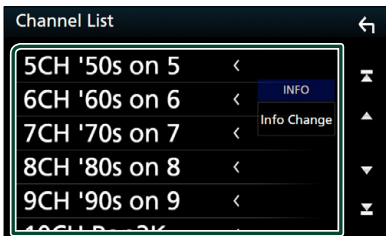

#### NOTE

- All channels in the selected category appear.
- Touching **All-Channels** displays all channels.
- Touch **Info Change** in the channel list. Select a desired item.  
Content info, channel name, artist name, song title, category name
- Categories which have the prefix "Featured -" are Featured Favorites.
- Featured Favorites are groups of channels that are created by the SiriusXM Programming department allowing you to discover new channels. Featured Favorite channels are dynamic and can change often, allowing you to discover new channels.
  - You can set whether to be notified when the featured seasonal theme is updated. **(P.59)**

## Replay

You can replay the last 60 minutes of the program from the current channel.

### 1 Touch **▶II** or **Replay** on the function panel.

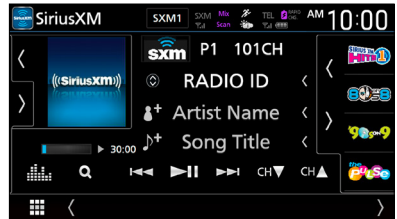

Press to skip to the previous/next track.

Press and hold to rewind or fast forward. (It will be cancelled automatically after about 50 seconds.)



Plays or pauses.

#### ■ **Replay time bar/ Play mode indicator**

Displays the recorded data capacity and playback position.

▶▶▶, etc.: Current play mode indicator



Displays a list of recorded data on a program basis.

### 2 Touch **Q** to display an Instant Replay List screen.

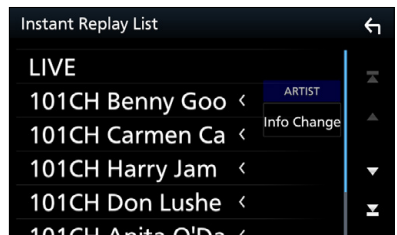

#### ■ **Instant Replay List**

Touching this plays back the displayed program.

**LIVE**: Touch to return to the live music/content.

#### ■ **Info Change**

Touch **Info Change**. Select a desired item.

Content info, channel name, artist name, song title, category name

## To return to live music/content

- 1 Touch the left side of the screen.
- 2 Touch **Live**.

## TuneMix™

TuneMix™ plays a unique blend of songs from your Preset music channels of the current SiriusXM Preset Band, allowing you to build a custom channel from as few as two to as many as 6 music channels. You can even skip songs you don't want to hear.

- 1 Touch  on the left side of the screen. Touch **TuneMix** to set ON or OFF.

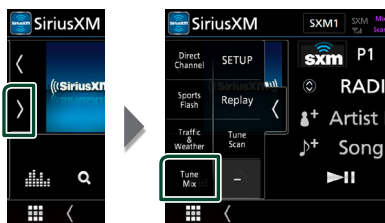

### NOTE

- Compatible with SXV300 or later tuner models.

## SmartFavorites, TuneStart™

Preset channels 1 through 6 of the current band are SmartFavorites channels.

The SiriusXM Vehicle Tuner automatically buffers the broadcast audio content of the SmartFavorites channels in the background.

You can rewind and replay up to 30 minutes of any of the missed news, talk, sports or music content on SmartFavorites channels. (see **Replay (P.51)**)

When tuning in a SmartFavorites channel, songs will be played from the beginning of each track (TuneStart™). You can enable/disable TuneStart. (see **TuneStart™ (P.59)**)

### NOTE

- Compatible with SXV200 or later tuner models.

## TuneScan™

TuneScan™ is a feature that plays samples from the starts of multiple buffered songs from each of the SmartFavorites channels that predominantly play music selections.

You have easy access to a large sampling of music content and can enjoy hearing a full song by stopping the scan on a song of interest.

- 1 Touch  on the left side of the screen.

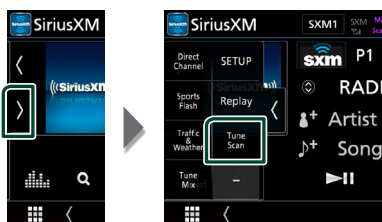

- 2 Touch **TuneScan** to begin scanning your SmartFavorites channels.

You will hear a few seconds of the songs from each of the SmartFavorite channels.

- 3 While your favorite song is being played, touch **TuneScan** again to start listening to that song.

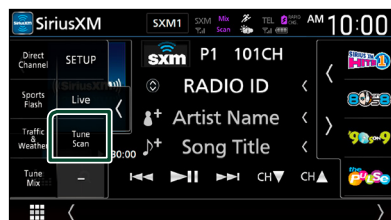

- Scan finishes and the song is played continuously.

### NOTE

- To cancel TuneScan™, touch the left side of the screen. Touch **TuneScan**.
- Touch and hold **TuneScan** to cancel TuneScan, and the music/content which was present on the channel before starting TuneScan will be played.
- Compatible with SXV200 or later tuner models.

## Traffic & Weather Now™

Traffic & Weather Now™ allows you to access the latest report whenever you want to hear it. Select your city in the set up menu **Select a City for Traffic & Weather (P.59)**.





- 1 Touch  on the left side of the screen.



- 2 Touch **Traffic & Weather**.

The report starts from the beginning. To stop and return to the previous channel, touch it again.

### Indicator display

-  (White) : Played already.
-  (Green) : New information arrived.
-  (Purple) : Playing.
-  (Gray) : No information.

### NOTE

- Compatible with SXV300 or later tuner models.

## Content Alerts

When a broadcast program related to the registered artist, song or team starts, an Alert Content List screen appears to allow you to switch the current channel to the relevant channel.

- 1 When the broadcast of the registered content starts, an Alert Content List screen appears.

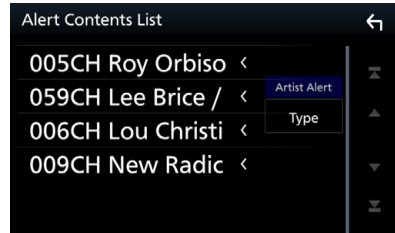

- 2 Select a content from the list.

### NOTE

- Touch **Info Change**. Select a desired item. Artist Alert, Song Alert, GameAlert™
- To learn how to register artists and songs for the Content Alert function, see  Information display in **SiriusXM® Basic Operation (P.48)**.
- To learn how to set up the Content Alerts function and select Teams for alerts, see **Content Alerts setup (P.56)**.

## SportsFlash™

SportsFlash™ will notify you when a big play happens during a game with one of your favorite sports teams. Choose to tune in and hear the play unfold like it was live. Continue listening to the game or return to your previous channel.

- 1 When a big play happens during one of the games, an Alert screen appears.

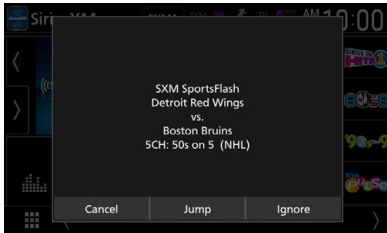

### ■ Jump

Touch to tune in that channel and play back the big play.

### ■ Ignore

Touch to cancel this specific SportsFlash alert. Touching **Ignore** will ignore this specific alert but will allow future alerts for this game.

### ■ Cancel

Touch to cancel SportsFlash alert. No alerts for this game will be displayed afterward.

## NOTE

- Compatible with SXV300 or later tuner models.
- To learn how to set up the SportsFlash alert function, see **SportsFlash™ setup (P.58)**.

## SiriusXM Setup

- 1 Touch **>** on the left side of the screen. Touch **SETUP**.

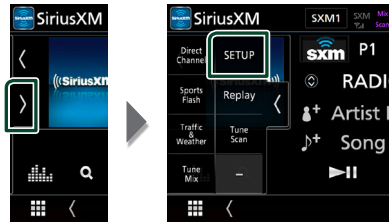

- ▶ SiriusXM SETUP screen appears. See the following sections for each setting.
  - Set up the parental code **(P.55)**
  - Set up the Parental Control **(P.55)**
  - Set up the skip channel select **(P.56)**
  - Set up the Content Alerts **(P.56)**
  - Set up the teams for SportsFlash™ **(P.58)**
  - Select the city for Traffic & Weather Jump or Traffic & Weather Now™ **(P.59)**
  - Select the Featured Bands Update Messages **(P.59)**
  - Set up the TuneStart™ **(P.59)**
  - Reset to the default settings **(P.59)**

## Parental code

You can set a SiriusXM parental code for Parental Control.

### 1 Touch **Parental Code** on the SiriusXM SETUP screen.

- Parental Pass Check screen appears.

#### NOTE

- The code number is set to "0000" as default.

### 2 Enter the current code number and touch **Enter**.

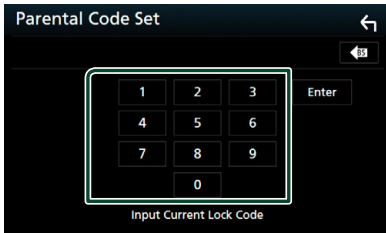

- Parental Pass 1st screen appears.

### 3 Enter the new code number and touch **Enter**.

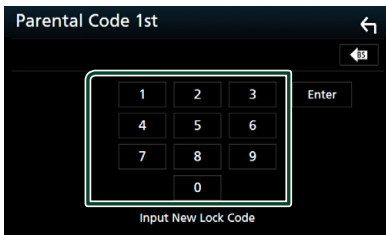

- Parental Pass 2nd screen appears.

### 4 Enter the same code number as that you entered in step 3 and touch **Enter**.

- The code number is confirmed and the SiriusXM parental code is now set.

## Parental Control

Parental Control is a feature that provides the user with the ability to prevent unauthorized access to mature content and user selected channels.

### 1 Touch **Parental Control** on the SiriusXM SETUP screen.

### 2 Touch **Mature, User or OFF**.

#### ■ OFF

Deactivates the parental mature and user locks.

#### ■ Mature

Locks channels classified as "mature" only.

#### ■ User

Locks only the selected channels.

### 3 Enter the parental code you originally input in as stated in *Parental code (P.55)* and touch **Enter**.

#### When selecting User

This allows you to limit access to any SiriusXM channel (Parental Lock Channel).

### 1 Touch **Parental Lock Channel Selection** on the SiriusXM SETUP screen.

- Parental Pass Check screen appears.

#### NOTE

- You need to set up a parental code beforehand as stated in *Parental code (P.55)*.

### 2 Enter the parental code you originally input as stated in *Parental code (P.55)* and touch **Enter**.

- Parental Lock Category Select screen appears.

### 3 Touch the desired category in the list.

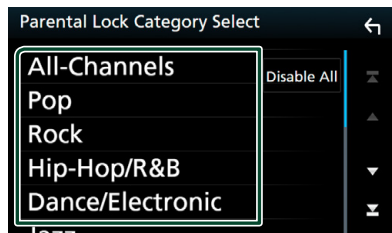

- Displays all channels in the selected category.

**NOTE**

- Touch **All-Channels** to display all channels.
- To delete the parental lock channel setting, touch **Disable All** and then touch **YES** on the confirmation screen.

**4** Touch each channel on the list and set to ON or OFF.

ON: Locks the channel.

OFF: Unlocks the channel.

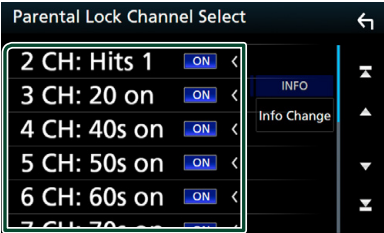

**NOTE**

- Touch **Info Change**. Select a desired item, Content information, Channel name, Artist name, Song title, Category name.

**Skip channel select**

You can set the undesired channels to skip.

**1** Touch **Skip Channel Select**.

- Skip Category Select screen appears.

**2** Touch the desired category from the list.

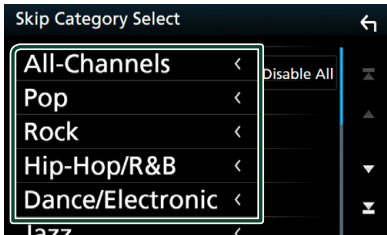

- Displays all channels in the selected category.

**3** Touch each channel in the list and set to ON or OFF.

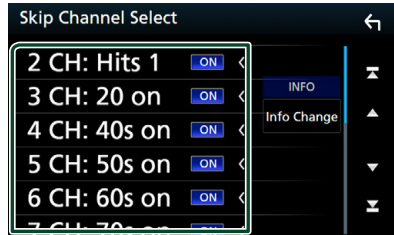

**NOTE**

- To delete the skip channel setting, touch **Disable All** and then touch **YES** on the confirmation screen.
- Touch **Info Change**. Select a desired item, Content information, Channel name, Artist name, Song title, Category name.
- Direct Channel and Preset Memory functions allow you to select channels.

**Content Alerts setup**

*Activating content alert*

**1** Touch **Content Alerts** on the SiriusXM SETUP screen.

- Content Alerts is turned on or off. Default is "ON".

*Selecting the content for Content Alerts*

**1** Touch **Content Alerts Contents Set** on the SiriusXM SETUP screen.

**2** Select the content you want to set up.

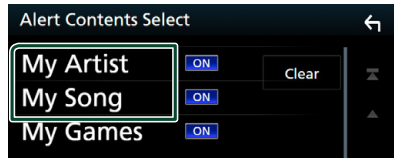

**NOTE**

- To cancel all alert contents, touch **Clear** and then touch **YES** on the confirmation screen.
- Select **OFF** for the content you want to deactivate the content alert for.

- 3** Touch each content list item you want to check or uncheck.



**NOTE**

• You can select (☑) up to 60 artists or songs.

- **To delete the Artist and Song**

- 1** Touch **Delete**.

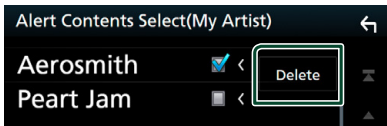

- 2** Touch the content(s) in the list you want to select.

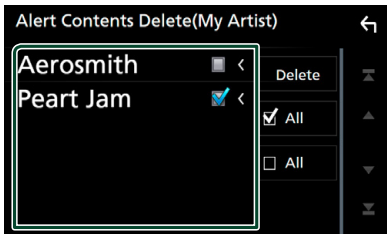

**All**  
Selects all contents.

**All**  
Clears all check marks.

- 3** Touch **Delete** and then touch **YES** on the confirmation screen.

**To select a Team**

Get alerted when your favorite sports team is playing on another SiriusXM channel with GameAlert™

- 1** Touch **My Games**.

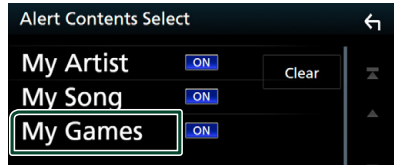

- 2** Touch the desired league in the list.

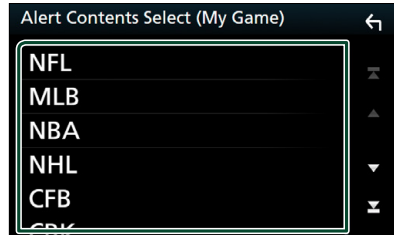

- 3** Touch the team(s) in the list you want to select.

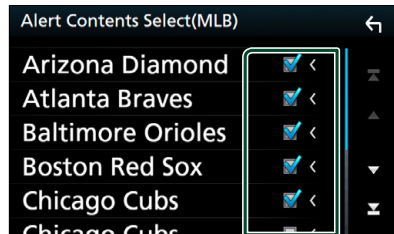

**NOTE**

• You can select (☑) up to 30 teams.

## SportsFlash™ setup

### Activating SportsFlash

1 Touch **SportsFlash** on the SiriusXM SETUP screen.

- SportsFlash is turned on or off. Default is "ON".

### Selecting SportsFlash Beep

1 Touch **SportsFlash Beep** on the SiriusXM SETUP screen.

- SportsFlash Beep is turned on or off. Default is "ON".

### Selecting the teams for SportsFlash

1 Touch **SportsFlash Team Set** on the SiriusXM SETUP screen.

- Team Set screen appears.

2 Touch **Edit**.

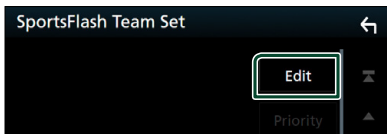

3 Touch the desired league in the list.

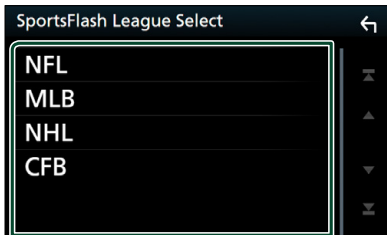

4 Touch each team(s) in the list you want to select.

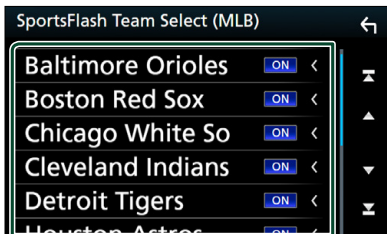

5 Touch  twice.

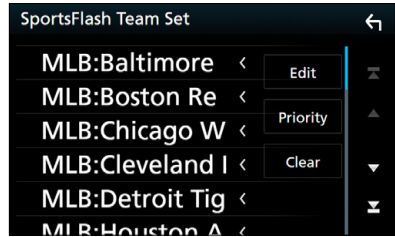

#### ■ Edit

Sets and removes teams.

#### ■ Priority

Sets the priority of a team.

#### ■ Clear

Removes all teams that have been set.

Touch **Clear**. When the confirmation screen appears, touch **YES**.

#### NOTE

- SportsFlash™ is available on SXV300 or later tuner models.
- Up to 50 teams can be added.

### Set the SportsFlash™ Team Priority

1 Touch **Priority**.

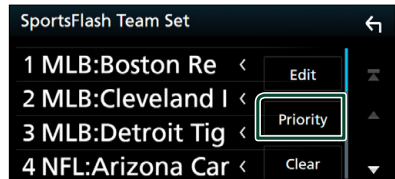

2 Set the priority of a team.

Each time you touch a Team, the priority is set of reset.



### 3 Touch **Done**.



#### NOTE

- Priority can be set on up to 5 teams.
- When priority has already been set for 5 teams, it cannot be set for any other team. Delete an unnecessary team.

### Select a City for Traffic & Weather

You can select a city for which you wish to receive SiriusXM Traffic & Weather broadcasts and hear them from the beginning.

- 1 Touch **Traffic & Weather City Select** on the SiriusXM SETUP screen.
- 2 Touch ◀ and ▶ to select a city.

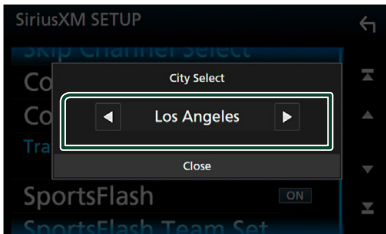

### Selecting Featured Bands Update Messages

You can set whether to be notified when the featured seasonal theme is updated.

- 1 Touch **Featured Bands Update Messages** on the SiriusXM SETUP screen. Featured Bands Update Messages is turned on or off.

### TuneStart™

- 1 Touch **Tune Start** on the SiriusXM SETUP screen. The TuneStart is turned on or off. Default is "ON".

### Reset

- 1 Touch **SiriusXM Reset** on the SiriusXM SETUP screen.
  - Confirmation screen appears.
- 2 Touch **YES**.
  - All SiriusXM settings are reset to defaults.

# Bluetooth Control

Using the Bluetooth function allows you to use various functions such as listening to the audio file and making/receiving a call.

## Information for using Bluetooth® devices



Bluetooth is a short-range wireless radio communication technology for mobile devices such as mobile phones, portable PCs, and other devices.

Bluetooth devices can be connected without cables and communication with each other.

### NOTE

- While driving, do not perform complicated operations such as dialing numbers, using the phone book, etc. When you perform these operations, stop your car in a safe place.
- Some Bluetooth devices may not be connected to this unit depending on the Bluetooth version of the device.
- This unit may not work for some Bluetooth devices.
- Connecting conditions may vary depending on your environment.
- Some Bluetooth devices are disconnected when this unit is turned off.

## About the cell-phone and Bluetooth audio player

This unit conforms to the following Bluetooth specifications:

### Version

Bluetooth Ver. 4.1

### Profiles

#### Cell-phone:

HFP (V1.7) (Hands Free Profile)

SPP (Serial Port Profile)

PBAP (Phonebook Access Profile)

#### Audio player:

A2DP (Advanced Audio Distribution Profile)

AVRCP (V1.6) (Audio/Video Remote Control Profile)

#### Sound codec

SBC, AAC

### NOTE

- The units supporting the Bluetooth function have been certified for conformity with the Bluetooth Standard according to the procedure prescribed by Bluetooth SIG.
- However, it may be impossible for such units to communicate with your cell-phone depending on its type.

## Register the Bluetooth device

It is necessary to register the Bluetooth audio player or cell-phone in this unit before using the Bluetooth function.

You can register up to 10 Bluetooth devices.

### NOTE

- Up to 10 Bluetooth devices can be registered. If an attempt is made to register the 11th Bluetooth device, the Bluetooth device connected on the earliest date will be deleted to register the 11th one.
- This unit is compatible with the Apple Easy Pairing function. When an iPod touch or iPhone is connected to this unit, an authentication dialog appears. Performing operation for authentication on this unit or iOS smartphone registers the smartphone as a Bluetooth device.

**1 Search for the unit ("DNX\*\*\*\*") from your smartphone/cell-phone.**  
Complete steps 1 to 4 within 30 seconds.

**2 Operate your smartphone/cell-phone according to the displayed messages.**

- **Confirm the request both on the smartphone/cell-phone.**

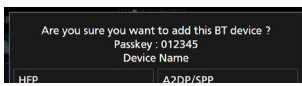

- **Input the PIN Code in your smartphone/cell-phone.**

PIN Code is set to "0000" as the default.

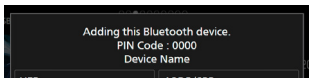

**3 Select the function you want to use.**

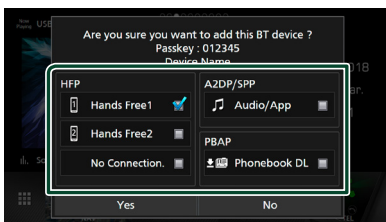

- **HFP Hands Free1 / Hands Free2 / No Connection.**

Select the hands-free number to connect.

- **A2DP/SPP Audio/App**

Select if you want to use the audio player app in your smartphone over A2DP, and the other apps in your smartphone over SPP.

- **PBAP Phonebook DL**

Select if you want to transfer your phonebook data.

**4 Touch Yes.**

When data transmission and connection have completed, the Bluetooth connection icon appears on the screen.

## Bluetooth Setup

**1 Press the MENU button.**

➤ Pop up menu appears.

**2 Touch SETUP.**



➤ SETUP Menu screen appears.

**3 Touch Bluetooth.**

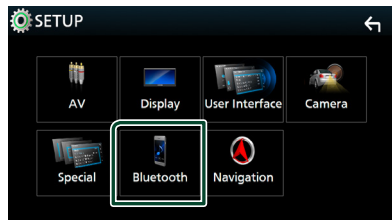

➤ Bluetooth SETUP screen appears.

See the following section for each setting.

- Connect the Bluetooth device (**P.62**)
- Change the PIN Code (**P.63**)
- Change the device name (**P.63**)

## Connect the Bluetooth device

- 1 Touch **Select Device** on the Bluetooth SETUP screen.

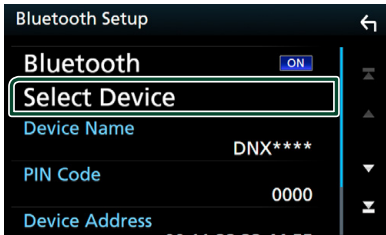

- 2 Touch the name of the device you want to connect.

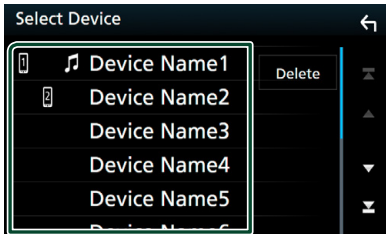

➤ Profile select screen appears.

### NOTE

- If the icon is lighted, it means that the unit will use that device.

- 3 Set each profile as follows.

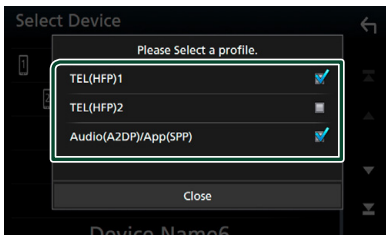

### ■ TEL (HFP) 1, TEL (HFP) 2

Select when the device is connected with the unit as hands-free phone 1 or 2.

### ■ Audio (A2DP)/App (SPP)

Select to interwork with an application installed in a smartphone or to use as an audio player.

- 4 Touch **Close**.

## To delete the registered Bluetooth device

- 1 Touch **Delete**.

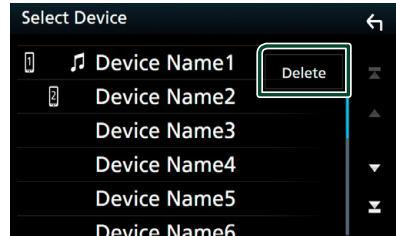

- 2 Touch the device name to check.

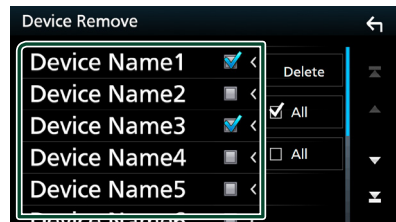

### ■ All

Selects all Bluetooth devices.

### ■ All

Clears all check marks.

- 3 Touch **Delete**.

➤ Confirmation message appears.

- 4 Touch **Yes**.

## Change the PIN Code

- 1 Touch **PIN Code** on the Bluetooth SETUP screen.
  - Change PIN Code screen appears.
- 2 Touch and hold **BS**.
- 3 Input the PIN Code.

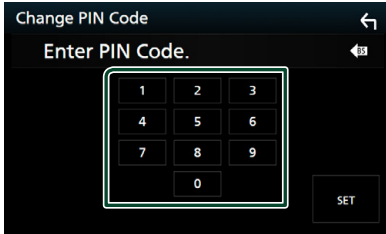

- 4 Touch **SET**.

## Change the device name

- 1 Touch **Device Name** on the Bluetooth SETUP screen.
  - Change Device Name screen appears.
- 2 Touch and hold **BS**.
- 3 Input the device name.



- 4 Touch **Enter**.

## Playing the Bluetooth Audio Device

Most function can be controlled from the source control screen.

To select Bluetooth source, touch **Bluetooth** icon on the source selection screen. (P.12)

## Bluetooth basic operation

### Control screen

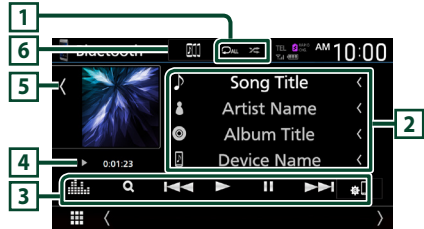

### 1 [Repeat] / [Shuffle] \*

- [Repeat]: Repeats the current track/folder. Each time you touch the key, repeat modes are switched in the following sequence: File repeat ([Repeat]), Folder repeat ([Folder]), All songs repeat ([Repeat]), Repeat off ([Repeat]).
- [Shuffle]: Randomly plays all tracks in the current folder. Each time you touch the key, random modes are switched in the following sequence: Folder random ([Shuffle]), All random ([Shuffle]), Random off ([Shuffle]).

### 2 [Information display] \*

- Displays the name of track information.
- Connected device name.

### 3 [Operation keys] \*

- [Search]: Searches for a file. See **File search** (P.65).
- [Previous/Next]: Searches for the previous/next content. Touch and hold to fast forward or fast backward. (It will be cancelled automatically after about 50 seconds.)
- [Play]: Plays.
- [Pause]: Pauses.
- [Bluetooth]: Displays the Bluetooth SETUP screen.
- [Equalizer]: Displays the Graphic Equalizer screen. (P.83)

**4 Play mode indicator/ Playing time**

- ▶, II: Current play mode indicator
- Meanings of individual icons are as follows:
- ▶ (play), ▶▶ (fast forward), ◀◀ (fast backward), II (pause), ■ (stop).

**5 Artwork**

Displays/hides artwork area.

**6 KENWOOD Music Mix**

Bluetooth audio devices can be switched easily to play music. See **KENWOOD Music Mix (P.64)**.





\*These items appear only when the audio player which supports AVRCP profile is connected.

**NOTE**



- The operation buttons, indications and information displayed on the screen differ depending on the connected device.
- If the operation keys do not appear, operate from the player.
- Depending on your cell-phone or audio player, sound may be heard and controlled but text information may not appear.
- If the volume is too low, raise it on your cell-phone or audio player.

**KENWOOD Music Mix**



Up to five Bluetooth audio device can be connected and switched easily to play music.

- 1 Touch** .  
▶ A list of registered devices is displayed.
- 2 Touch**  of device name you want to connect.
  - Touching  displays the Bluetooth device connection setup screen. (P.62)
  - Touching  on the left of the connected device (  ▶ ) disconnects this device.





-  : Device used normally.
-  : Device used for KENWOOD Music Mix

- 3 Touch**  (white) on the left of the name of the device to be played.

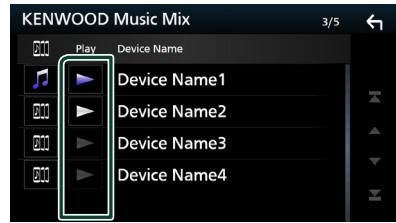
 (white) changes to  (purple) and starts playback.



-  (Gray) : Not connected.
-  (White) : Connected.
-  (Purple) : During playback.

- 4 Touch** .

**NOTE**

- If a connected Bluetooth audio device is operated to play music, connections are switched.
- When a Bluetooth source is switched to another one, its settings are deleted and the connection is restored to the connection before source switching.

## File search

- 1 Touch **Q**.
- 2 Touch the desired file or folder.

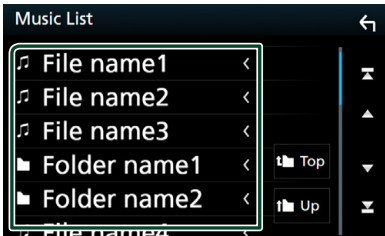

When you touch a folder its contents are displayed.

- 3 Touch the desired item in the content list.
  - Playback starts.

### NOTE

- For operations in the list screen, see **List screen (P.15)**.

## Using the Hands-Free Unit

You can use the telephone function by connecting the Bluetooth telephone to this unit.

### NOTE

- If you use the hands-free function frequently, move the TEL short-cut button (icon) to the Home screen. **(P.14)**
- While Apple CarPlay or Android Auto is connected, the Bluetooth Hands-Free function and two Bluetooth devices connections cannot be used. Only the Apple CarPlay or Android Auto Hands-Free function can be used.

## Make a call

- 1 Press the **HOME** button.
- 2 Touch .
- 3 Touch **TEL**.

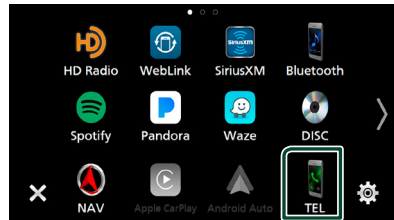

➤ Hands Free screen appears.

### NOTE

- If your mobile phone supports PBAP, you can display the phone book and call lists onto the touch panel screen when the mobile phone is connected.
  - Phone book: up to 1000 entries
  - Up to 50 entries including dialed calls, received calls, and missed calls

4 Select a dialing method.



- : Call using call records
- : Call using the phonebook
- : Call using the preset number
- : Call by entering a phone number

● Select the cell-phone to use

When you connect two cell-phones

- 1) Touch to select the phone you want to use.

● Bluetooth SETUP

- 1) Touch .  
Bluetooth SETUP screen appears.

● Voice Recognition

- 1) Touch . (P.67)

**NOTE**

- Status icons such as battery and antenna icons may differ from those displayed on the cell-phone.
- Setting the cell-phone in the private mode can disable the hands-free function.

*Call using call records*

- 1 Touch .
- 2 Select the phone number from the list.



*Call by entering a phone number*

- 1 Touch .
- 2 Enter a phone number with number keys.

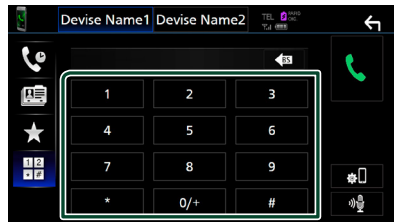



- 3 Touch .

*Call using the preset number*

- 1 Touch .
- 2 Touch the name or phone number.



## Call using the phonebook

- 1 Touch .
- 2 Touch .
- 3 Select the initial.



- Characters with no corresponding name will not appear.
- A first character with an accent character such as “ü” can be searched for with a non-accent character “u”. A character with an accent character in a sentence cannot be searched for.

- 4 Select the person you want to call from the list.

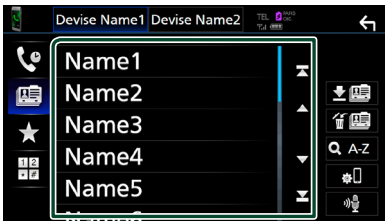

- 5 Select the phone number from the list.

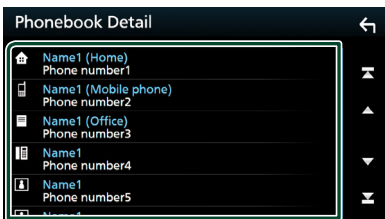

### NOTE

- You can sort the phone numbers in the list by last name or first name. For details, see **Hands-Free Setup (P.70)**.

## Voice Recognition

You can access the voice recognition function of the cell-phone connected to this unit. You can search the cell-phone phonebook by voice. (The functionality depends on the cell-phone.)

- 1 Press the  button for 1 second.

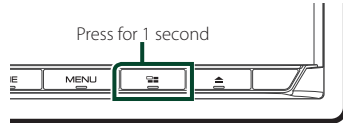



➤ Voice Recognition screen appears.

- 2 Start speaking.

### NOTE

- You can use the voice recognition function by touching  on the Hands Free screen.

## Receive a call

- 1 Touch  to answer a phone call or  to reject an incoming call.

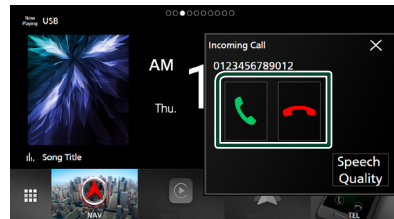

### NOTE

- While monitoring the picture from the view camera, this screen does not appear even if a call comes in.

## To end call

- 1 While talking, touch .

## Operations during a call

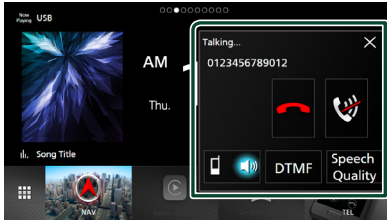

### ● Adjust the volume of your voice

- 1) Touch **Speech Quality**.
- 2) Touch ◀ or ▶ for **Microphone Level**.

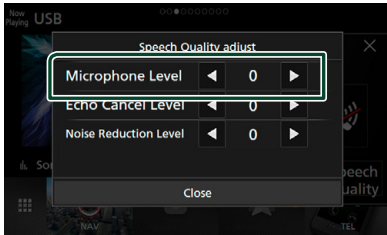

### ● Adjust the receiver volume

Press the ▼ or ▲ button.





### ● Mute your voice

Touch  to mute or not to mute your voice.

### ● Output the dial tone

Touch **DTMF** to display the tone input screen. You can send tones by touching desired keys on the screen.

### ● Switching between speaking voice output destinations

Touching  /  each time switches speaking voice output destinations between the cell-phone and the speaker.

### ● Call-waiting

When you receive a new call while talking on the phone, you can answer the newly received call by touching . The current call is put on hold.

Each time you touch , the caller will change to the other one.

When you touch , the current call will end to be switched to the call waiting on hold.

### ● To close the Hands-Free popup screen

Touching ✕ to close the Hands-Free popup screen.

#### To display it again

- ① Press the **HOME** button.
- ② Touch .
- ③ Touch **TEL**.

## Phone number preset

You can register frequently used phone numbers in this unit.

1 Touch .

2 Touch **Edit**.



3 Select where to preset.

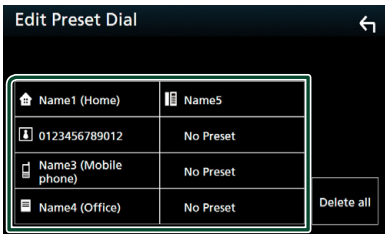

### Delete all

To delete all preset numbers, touch **Delete all** and then touch **OK** on the confirmation screen.

4 Select how to preset.

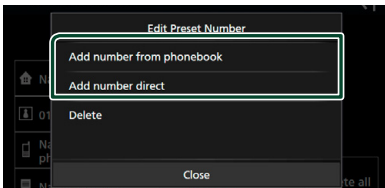

### Add number from phonebook

Select the number to preset from the phonebook. See **Call using the phonebook (P.67)**.

### Add number direct

Enter the telephone number directly and touch **SET**. See **Call by entering a phone number (P.66)**.

### Delete

To delete a preset number, touch **Delete** and then touch **OK** on the confirmation screen.

## Phonebook transfer

You can transfer phonebook data from your Bluetooth smartphone using PBAP.

1 Touch .

2 Touch .



> Phonebook data transfer starts.

### NOTE

- If the Phonebook contains more than 1000 entries, Phonebook data cannot be transferred.
- If no Phonebook has been downloaded, touching **Download Phonebook Now** will start downloading the Phonebook.

## Phonebook deletion

1 Touch .

2 Touch the name to check.

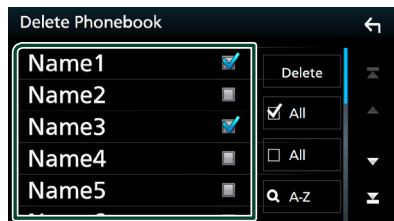

### All

Checks all boxes.

### All

Clears all check marks.

3 Touch **Delete**.

> Confirmation message appears.

4 Touch **OK**.

## Hands-Free Setup

You can make various settings for the Hands-Free function.

### 1 Press the **MENU** button.

➤ Popup menu appears.

### 2 Touch **SETUP**.



➤ SETUP Menu screen appears.

### 3 Touch **Bluetooth**.



➤ Bluetooth SETUP screen appears.

### 4 Touch **TEL SETUP**.

➤ TEL SETUP screen appears.

### 5 Set each function as follows.

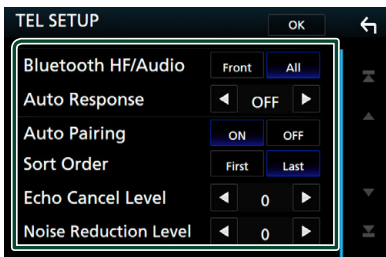

#### ■ **Bluetooth HF/Audio**

Select the speakers to output the sound from the cell-phone (such as phone call voice and ringing tone) and Bluetooth audio player.

**Front**: Outputs sound from the front speakers.

**All** (Default): Outputs sound from all speakers.

#### ■ **Auto Response**\*

Set the automatic response time to pick-up an incoming call.

**OFF** (Default): Turns off the Automatic response function.

**1 / 5 / 10 / 15 / 20 / 25 / 30**: Sets the ringing time (second).

#### ■ **Auto Pairing**

When set to "ON", the Apple Auto Pairing function is turned on to automatically register the iPod touch or iPhone connected to this unit.

**ON** (Default): Turns on the Apple Auto Pairing function.

**OFF**: Turns off the Apple Auto Pairing function.

#### ■ **Sort Order**

Set how to sort the data in the cell-phone phonebook.

**First**: Sorts data by the first name.

**Last** (Default): Sorts data by the last name.

#### ■ **Echo Cancel Level**

Adjust the level of echo cancellation.

Default is "0".

#### ■ **Noise Reduction Level**

Reduce the noise generated in the surrounding environment without changing the microphone volume. Use this function when the voice of caller is not clear. Default is "0".

\* Either the auto response time set on this unit or the time set on the cell-phone, whichever is shorter takes effect.

### 6 Touch **OK**.

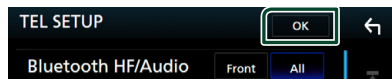

# Other External Components

## View Camera

### NOTE

- To connect a camera, see **P.97**.
- To use a rear view camera, a REVERSE lead connection is required. (**P.96**)
- If **Rear Camera Interruption** is active the camera screen is displayed when you shift the gear to the reverse (R) position.

### Display the camera screen

#### 1 Press the **MENU** button.

- Popup menu appears.

#### 2 Touch **Camera**.



- View camera screen appears.

#### 3 Adjust each item as follows.

To erase the caution message, touch the screen.

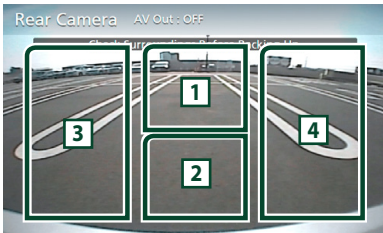

#### 1 **Switching the View Camera** \*1

Touch to change the front view camera or dashboard camera and rear view camera.

#### 2 **Camera off**

Touch to exit the camera screen.

#### 3 **Switching the Guideline** \*2

Touching each time turns on or off the guideline.

#### 4 **Switching the Angle** \*2

Touching each time changes camera angles:

\*1 When the front camera or dashboard camera, and rear camera are connected with this unit.

\*2 When CMOS-3xx series is connected with this unit.

### Camera Setup

#### 1 Press the **MENU** button.

- Popup menu appears.

#### 2 Touch **SETUP**.

- SETUP Menu screen appears.

#### 3 Touch **Camera**.

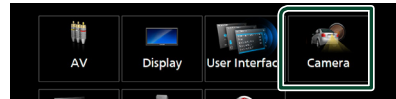

- Camera screen appears.

#### 4 Set each item as follows.

##### ■ **Rear Camera Interruption**

**ON**: Displays the picture from the rear view camera when you shift the gear to the reverse (R) position.

**OFF** (Default): Select this when no camera is connected.

##### ■ **Rear Camera Settings** \*1

Adjusts the CMOS-3xx series with ID 1 ("Rear Camera") set. For details, see the instruction manual of your camera.

##### ■ **Parking Guidelines**

You can display parking guidelines to enable easier parking when you shift the gear to the reverse (R) position.

Default is "ON".

##### ■ **Guidelines SETUP**

If you select **ON** for **Parking Guidelines**, you can adjust the parking guidelines. See **To adjust the parking guidelines (P.72)**.

##### ■ **Front Camera**

**ON**: Select this when the front camera is connected.

**OFF** (Default): Select this when no camera is connected.

## Other External Components

### ■ Front Camera Settings \*1

Adjusts the CMOS-3xx series with ID 2 ("Front Camera") set. For details, see the instruction manual of your camera.

### ■ Front Camera Interruption \*2

**10 sec / 15 sec (Default) / 20 sec:** The front camera screen is displayed when return the gear from the reverse (R) position.

**OFF:** Cancel.

\*1 When CMOS-3xx series is connected with this unit.

\*2 When CMOS-3xx series or front camera is connected with this unit.

## To adjust the parking guidelines

### NOTE

- Install the rear view camera in the appropriate position according to the instruction manual supplied with the rear view camera.
- When adjusting the parking guidelines, make sure to apply the parking brake to prevent the car from moving.

### 1 Touch **ON** of **Parking Guidelines** in the **Camera** screen. (P.71)

### 2 Touch **Guidelines SETUP** on the **Camera** screen.

### 3 Adjust the parking guidelines by selecting the mark.

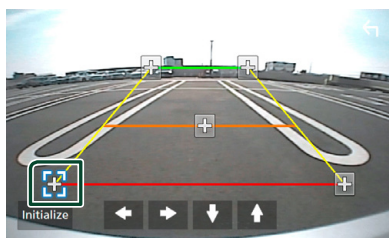

### 4 Adjusting the position of the selected mark.

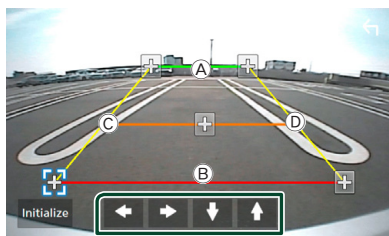

Make sure that lines (A) and (B) are horizontally parallel, and that lines (C) and (D) are of the same length.

### NOTE

- Touch **Initialize** and then touch **Yes** to set all the  marks to their initial default position.

## Use Dashboard Camera

A Dashboard Camera, DRV-N520 (optional accessory), connected to this unit lets you play video-recorded data and so on.

For details, see the instruction manual of the Dashboard Camera DRV-N520 (optional accessory).

### NOTE

- To connect a dashboard camera, see **P.98**.

## Display the dashboard camera screen

**1** Press the **MENU** button.

▶ Popup menu appears.

**2** Touch **Camera**.

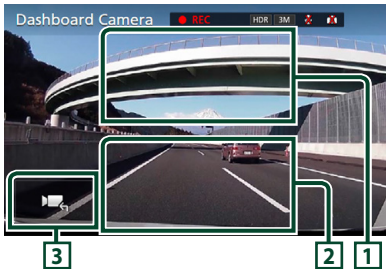

**1** **Switching the View Camera**

Touch to change the dashboard view camera and rear view camera.

**2** **Camera off**

Touch to exit the camera screen.

**3** **Key display**

Touch to display the dashboard camera control buttons.

## Added function

### Display the map while playing the recorded file

**1** Play the recorded file.

See the instruction manual of the Dashboard Camera.

**2** Touch .



### Return to the recorded file playback screen

**1** Touch .

## External audio/video players (AV-IN)

**1** Connect an external component to the AV-IN input terminal. (P.97)

**2** Select **AV-IN** as the source. (P.12)

**3** Turn on the connected component and start playing the source.

## OEM Features Operation

By connecting this unit to the bus system of the vehicle using an iDataLink (commercially available), this unit can access the satellite radio source provided for the vehicle and can display vehicle information on this unit.

**1 Press the HOME button.**

➤ HOME screen appears.

**2 Touch  on the HOME screen.**



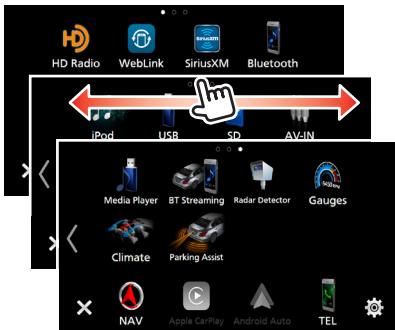





**3 Touch icon.**



**NOTE**

- Displayable screens, button names, and screen names vary depending on the type of the connected iDataLink and the model of the vehicle. For more details, access the following URL:

[www.idatalink.com/](http://www.idatalink.com/)

	• Displays the control screen of the satellite radio source provided for the vehicle.
	• Displays the control screen of the media player source provided for the vehicle.
	• Displays the control screen of the Bluetooth Hands Free function provided for the vehicle.
	• Displays the control screen of the Bluetooth streaming source provided for the vehicle.
	• Displays information about the instruments such as a speedometer.
	• Displays information about the air conditioner of the vehicle. *
	• Displays information about the Parking Distance Sensor of the vehicle.
	• Displays information about the tire pressures of the vehicle. *
	• Displays information about the Radar Detector. *

\* These ADS adapter features are displayed as the widget on the Home screen. **(P.11)** You can display the relevant screens by touching the widget.

# Setup

## Monitor Screen Setup

You can adjust the image quality of video, menu screen, etc.

- 1 Press the **MENU** button.  
➤ Popup menu appears.
- 2 Touch **Screen Adjustment**.

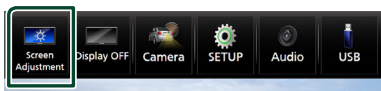

➤ Screen Control screen appears.

- 3 Adjust each setting as follows.

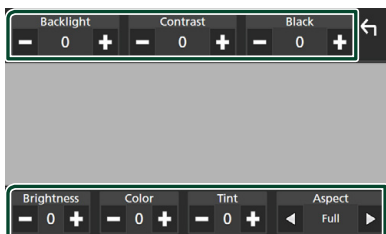

### ■ Backlight / Contrast / Black / Brightness / Color / Tint

Adjust each setting.

### ■ Aspect

Select a screen mode.

**Full**: Changes the aspect ratio of video and displays video fully on the screen.

**Normal**: Displays video at the ratio of 4:3.

#### Auto:

DVD, VCD and disc media: 16:9 video is displayed in the Full mode and 4:3 video is displayed in the Regular mode.

USB device and SD card: Displays video fully (vertically or horizontally) with no ratio change.

### NOTE

- Settings to adjust vary depending on the current source.

## System Setup

- 1 Press the **MENU** button.  
➤ Popup menu appears.
- 2 Touch **SETUP**.

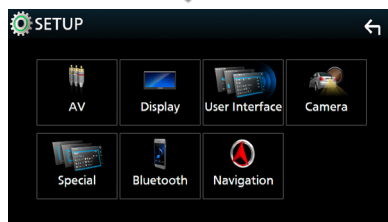

See the following section for each setting.

- Set up AV (**P.80**)
- Set up display (**P.78**)
- Set up the user interface (**P.76**)
- Set up camera (**P.71**)
- Set up special (**P.77**)
- Set up Bluetooth (**P.61**)
- Set up navigation (**P.19**)

## User Interface Setup

You can setup user interface parameters.

- 1 Press the **MENU** button.
  - Popup menu appears.
- 2 Touch **SETUP**.
  - SETUP screen appears.
- 3 Touch **User Interface**.



➤ User Interface screen appears.

- 4 Set each parameter as follows.

■ **Beep (DNX875S)**

Turn the key touch tone on or off.  
Default is "ON".

■ **Beep Volume (DNX995S)**

Set the sound volume of the key touch tone.  
"0" (Off) – "3" (Default) – "5"

■ **Widget SETUP**

Set up the widget displayed on the Home screen. (P.21)

■ **Parking Assist Display**

When an ADS adapter is connected, you can display information about obstacles around the car.

**ON**: Always displays information.

**Dyn.** (Default): Displays information when the sensor detects obstacles.

**OFF**: Cancels this function.

This can be set when the iDataLink (commercially available) is connected.

■ **Parking Assist Position**

Select where to display information about obstacles on the screen (left or right).

"Left"/"Right" (Default)

This can be set when the iDataLink (commercially available) is connected.

■ **Language Select Mode**

Selects the mode to select a language.

**Easy** (Default): Selects a language easily.

**Advanced**: Allows you to select languages for respective items.\*

■ **Language Select**

Select a language.

■ **Time Format**

Select the time display format.

"12-Hour" (Default)/ "24-Hour"

■ **Clock**

**NAV-SYNC** (Default): Synchronizes the clock time with navigation GPS data.

**Manual**: Set the clock manually.

■ **Time Zone**

If you have selected **Manual** for Clock, select the time zone.

■ **Clock Adjust**

If you select **Manual** for Clock, adjust the date and time manually. (P.77)

*\* If you select **Advanced for Language Select Mode**, the following screen appears.*

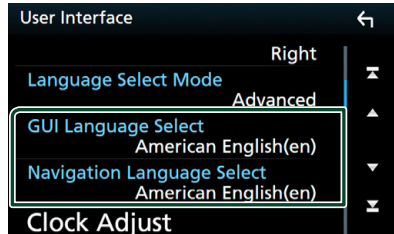

■ **GUI Language Select**

Selects the display language used for the control screen and so forth.

■ **Navigation Language Select**

Selects the language used for navigation.

## Adjust the date and time manually.

- 1 Touch **Clock** on the User Interface screen.
- 2 Select **Manual**.
- 3 Touch **Time Zone** on the User Interface screen.
- 4 Select the time zone.
- 5 Touch **Clock Adjust** on the User Interface screen.
- 6 Adjust the date, then adjust the time.

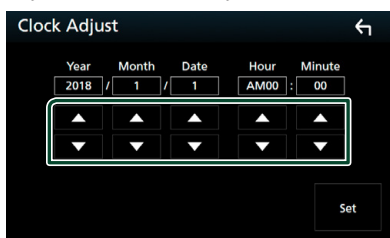

- 7 Touch **Set**.

## Special Setup

You can setup special parameters.

- 1 Press the **MENU** button.
  - Popup menu appears.
- 2 Touch **SETUP**.
  - SETUP screen appears.
- 3 Touch **Special**.

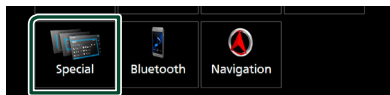

➤ Special screen appears.

- 4 Set each parameter as follows.

### DEMO

Select the demonstration mode. Default is "ON".

### Software Information

Confirm the software version of this unit.

(P.77)

### Open Source Licenses

Display the open source licenses.

### Initialize

Touch **Initialize** and then touch **Yes** to set all the settings to the initial default settings.

- Audio SETUP Memory is not initialized.

## Software Information

You can confirm the software version of this unit.

- 1 Touch **Software Information** in the Special screen.
- 2 Confirm the software version.

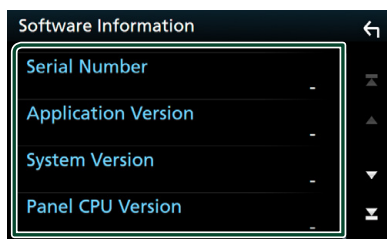

### NOTE

- For how to update the software, see the relevant update procedure manual which comes with the software.

## Display Setup

- 1 Press the **MENU** button.
  - Popup menu appears.
- 2 Touch **SETUP**.
  - SETUP screen appears.
- 3 Touch **Display**.

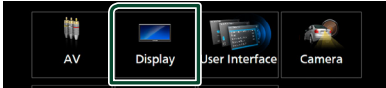

➤ Display screen appears.

- 4 Set each parameter as follows.

### ■ Dimmer

Select the dimmer mode.

**OFF**: Does not dim the display and buttons.

**ON**: Dims the display and buttons.

**SYNC** (Default): Turns the dimmer function on or off when the vehicle light control switch is turned on or off.

**NAV-SYNC**: Turns the dimmer function on or off according to the Navigation Day/Night display setting.

### ■ OSD Clock

Select if you want to display the clock while watching DVD video, etc.

"ON" (Default)/ "OFF"

### ■ Key Color

You can set the button illumination color. (P.78)

### ■ Wallpaper Customize

You can change the wallpaper image or color. (P.79)

### ■ Viewing Angle

If it is hard to see the image on the screen evenly, adjust the viewing angle. The smaller (the negative) value, the more whitish the image on the screen looks.

"0" (Default)/ "-1"/ "-2"/ "-3"

### ■ Screen transition effect

Select whether to use the screen transition effect when the source control screen is switched to the Home screen.

"ON" (Default)/ "OFF"

## ■ Customizing the key color

You can set the button illumination color.

- 1 Touch **Key Color** on the Display screen.
- 2 Touch the desired color.

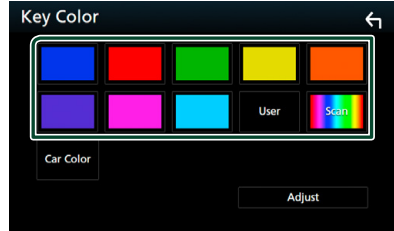

### ■ User

The color you have set in the process of **Adjust** is registered.

### ■ Scan

You can set the key color to continuously scan through the color spectrum.

### ■ Car Color

This can be selected when a compatible ADS adapter is connected.

- 3 Touch .

## To register an original color

You can register your original color.

- 1 Touch **User** on the Key Color screen.
- 2 Touch **Adjust**.
- 3 Use **-** and **+** to adjust each color value.

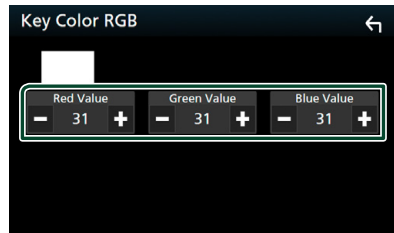

- 4 Touch .

## Change the wallpaper image or color

- 1 Touch **Wallpaper Customize** on the Display screen.
- 2 Select an image.

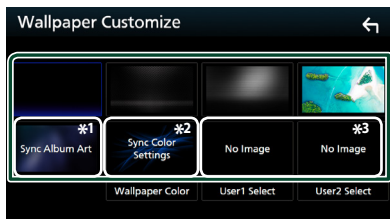

\*1 The album art currently being displayed is used as a wallpaper.

\*2 Select a wallpaper color in advance.

\*3 Select an original image in advance.

### To select wallpaper color

- 1 Touch **Wallpaper Color** on the Background screen.
- 2 Select a wallpaper color.



\*1 The color you have selected at **Key Color** is added on the image. If you select "Scan" at **Key Color**, you cannot select this image.

- 3 Touch .

### To register an original image

You can load an image from the connected USB device and set it as the wallpaper image. Before starting this procedure, it is necessary to connect the device which has the image to load.

- 1 Touch **User1 Select** or **User2 Select** on the Wallpaper Customize screen.
- 2 Select the image to load.

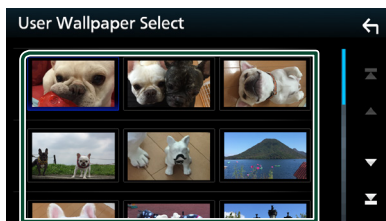

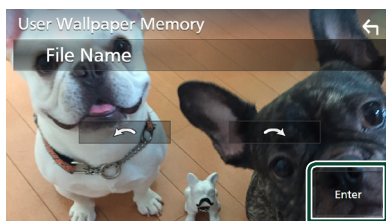

- 3 Touch **Enter**.



- The selected image is loaded and the display returns to the Wallpaper Customize screen.

### NOTE

- Touching  rotates the image counter-clockwise.
- Touching  rotates the image clockwise.
- Picture files: JPEG (.jpg, .jpeg), PNG (.png), BMP (.bmp)

## AV Setup

You can set AV parameters.

- 1 Press the MENU button.**
  - Popup menu appears.
- 2 Touch SETUP.**
  - SETUP screen appears.
- 3 Touch AV.**

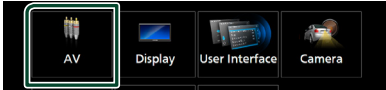

➤ AV screen appears.

- 4 Set each parameter as follows.**

### ■ Android Auto Device Select

Select the device to be used in the Android Auto mode. **(P.30)**

### ■ AV-OUT

You can select an AV source to be output from the AV OUTPUT port.

OFF, AV-IN, DISC, USB, SD, or iPod

- You cannot select iPod if it is connected via Bluetooth.
- If you select USB, SD, iPod, Disc, Spotify, Pandora or Bluetooth audio as the main source, you cannot select USB, SD or iPod as the AV output source.
- If you select Mirroring (WebLink/ Waze), Apple CarPlay or Android Auto as the main source, you cannot select DISC (Music CD/ Disc media), USB, SD or iPod as the AV output source.

### ■ Driving Position

Select the driving position (left or right).

“Left” (Default)/“Right”

### ■ OEM SETUP

Confirm the information about or change the settings for using the ADS adapter.

# Controlling Audio

You can adjust various settings such as audio balance or subwoofer level.

## 1 Press the **MENU** button.

- ▶ Popup menu appears.

## 2 Touch **Audio**.

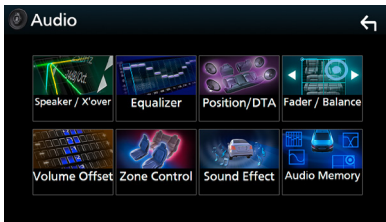
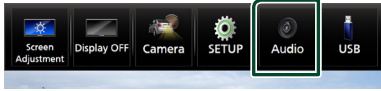

See the following section for each setting.

- Set up speaker/ X'over (**P.81**)
- Controlling equalizer (**P.83**)
- Set listening position/ DTA (**P.86**)
- Controlling general audio (Fader / Balance) (**P.82**)
- Set volume offset (**P.84**)
- Performing zone control (**P.84**)
- Set sound effect (**P.85**)
- Memory/recall the audio settings (**P.87**)

## Speaker/ X'over setup

### 1 Press the **MENU** button.

- ▶ Popup menu appears.

### 2 Touch **Audio**.

- ▶ Audio screen appears.

### 3 Touch **Speaker/X'over**.

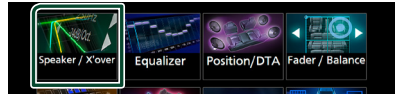

### 4 Select a car type.

You can select the car type and speaker network, etc.

When you select your car type, the Delay Time Alignment is activated automatically (for timing adjustment of sound output for each channel) to have the highest surround effects.



### 5 Touch the speaker (1) you wish to adjust and set each parameter (2) as follows.

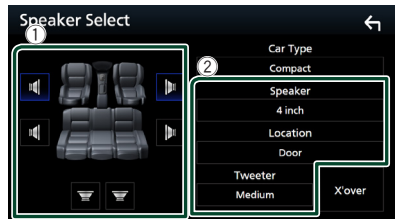

#### ■ **Speaker**

You can select a speaker type and its size to get the best sound effects.

When the speaker type and size are selected, the speaker crossover network is set automatically.

#### ■ **Location (Only for Front, Rear)**

Select the speaker position you have installed.

## Controlling Audio

### ■ Tweeter (Only for Front)

You can set up the tweeter when you are selecting front speakers.

None, Small, Medium, Large

### ■ X'over

Display the speaker crossover setup screen.

You can adjust the crossover frequency that was set automatically when you selected the speaker type.

For details, see **Crossover network setup (P.82)**

## ■ Crossover network setup

You can set the crossover frequency of speakers.

### 1 Touch X'over .



### 2 Touch the speaker to set up.



### 3 Set each parameter as follows.

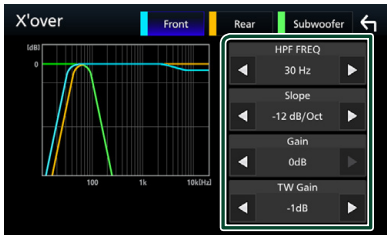

### ■ HPF FREQ

High Pass Filter adjustment. (When Front or Rear is selected on the Speaker Select screen)

### ■ LPF FREQ

Low Pass Filter adjustment. (When Subwoofer is selected on the Speaker Select screen)

### ■ Slope \*1

Set a crossover slope.

### ■ Gain

Adjust the gain of the front speaker, rear speaker, or subwoofer.

### ■ TW Gain \*2

Adjust the tweeter level. (When Front is selected on the Speaker Select screen)

### ■ Phase Inversion \*3

Set the phase of subwoofer output.

Check **Phase Inversion** to shift the phase 180 degrees. (When Subwoofer is selected on the Speaker Select screen)

\*1 Only when "LPF FREQ"/"HPF FREQ" is set to a mode other than "Through" in **X'over** .

\*2 Only when "Tweeter" is set to "Small", "Medium", "Large" in **Speaker Setup** .

\*3 Only when "Subwoofer" is set to a mode other than "None" in **Speaker Setup** .

## Controlling General Audio

### 1 Press the MENU button.

▶ Popup menu appears.

### 2 Touch Audio .

▶ Audio screen appears.

### 3 Touch Fader / Balance .

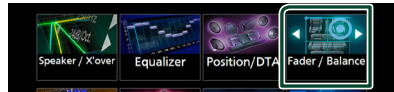

### 4 Set each parameter as follows.

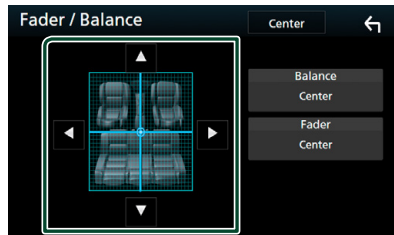

### ■ Fader / Balance

Adjust the volume balance around the touched area.

◀ and ▶ adjust the right and left volume balance.

▲ and ▼ adjust the front and rear volume balance.

### ■ Center

Clear the adjustment.

## Equalizer Control

You can adjust equalizer by selecting the optimized setting for each category.

- 1 Press the **MENU** button.
  - ▶ Popup menu appears.
- 2 Touch **Audio**.
  - ▶ Audio screen appears.
- 3 Touch **Equalizer**.



- 4 Touch the screen and set the Graphic Equalizer as desired.

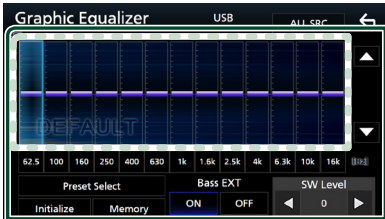

### ■ Gain level (area in dotted frame)

Adjust the gain level by touching each frequency bar.

You can select a frequency bar and adjust its level by ▲, ▼.

### ■ Preset Select

Display the screen for selecting the preset equalizer curve. (P.83)

### ■ Memory

Saves the adjusted equalizer curve as "User1" to "User4". (P.83)

### ■ Initialize

Initialize (flatten) the current EQ curve.

### ■ ALL SRC

Apply the adjusted equalizer curve to all sources. Touch **ALL SRC** and then touch **OK** on the confirmation screen.

### ■ Bass EXT (Bass Extend Settings)

When turned on, the frequencies lower than 62.5 Hz is set to the same gain level (62.5 Hz).

### ■ SW Level

Adjust the subwoofer volume. This setting is not available when Subwoofer is set to "None". See **Speaker/ X'over setup (P.81)**.

## ■ Recall the EQ curve

- 1 Touch **Preset Select**.
- 2 Select an EQ curve.

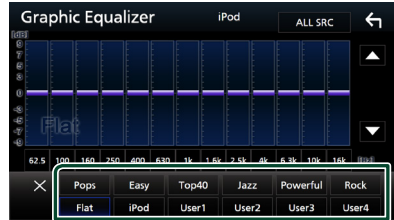

### NOTE

- **iPod** is available only for the iPod source.

## ■ Save the EQ curve

- 1 Adjust the EQ curve.
- 2 Touch **Memory**.
- 3 Select where to save.

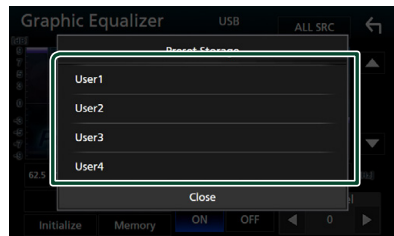

## Volume Offset

Finely adjust the volume of the current source to minimize the difference in volume between different sources.

- 1 Press the **MENU** button.
  - Popup menu appears.
- 2 Touch **Audio**.
  - Audio screen appears.
- 3 Touch **Volume Offset**.

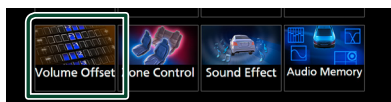

- 4 Touch **+** or **-** to adjust the level.

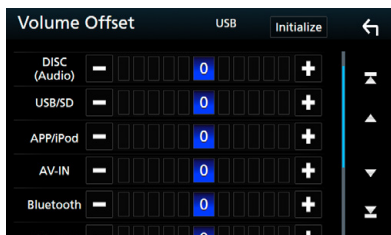

### ■ Initialize

Returns to the initial settings.

### NOTE

- If you have increased the volume first, then reduce the volume using "Volume Offset". Switching the current source to another source suddenly may output extremely loud sound.

## Zone Control

You can select different sources for front and rear positions in the vehicle.

- 1 Press the **MENU** button.
  - Popup menu appears.
- 2 Touch **Audio**.
  - Audio screen appears.
- 3 Touch **Zone Control**.



➤ Zone Control screen appears.

- 4 Touch **Zone Select**.

- 5 Touch **Dual Zone**.

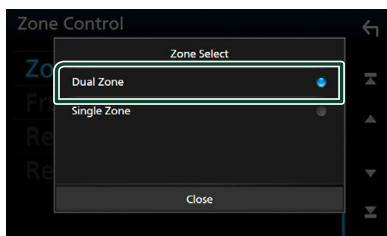

- 6 Set each source as follows.

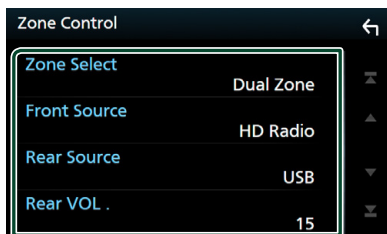

### ■ Zone Select

Touch **Single Zone** to turn off the dual zone function.

### ■ Front Source Rear Source

Select an audio source for each.

### ■ Rear VOL.

Adjust the rear source volume.

**NOTE**

- When the rear speaker sound is switched, the audio source that is output at the AV OUTPUT terminal is also switched to the same source.
- When the dual zone function is set to on, the following functions are not available.
  - Output from the subwoofer
  - Subwoofer Level/ Bass Boost **(P.85)**
  - Equalizer Control/ Sound Effect/ Listening Position **(P.83, 85, 86)**
  - Speaker Setup **(P.81)**
  - High-resolution Sound Source File Playback
- You cannot select iPod if it is connected via Bluetooth.
- If you select USB, SD, iPod, Disc, Spotify, Pandora or Bluetooth audio as the Front Source, you cannot select USB, SD or iPod as the Rear Source.
- If you select Mirroring (WebLink/ Waze), Apple CarPlay or Android Auto as the Front Source, you cannot select DISC (Music CD/ Disc media), USB, SD or iPod as the Rear Source.

**Sound Effect**

You can set sound effects.

- 1 Press the MENU button.**
  - Popup menu appears.
- 2 Touch Audio .**
  - Audio screen appears.
- 3 Touch Sound Effect.**

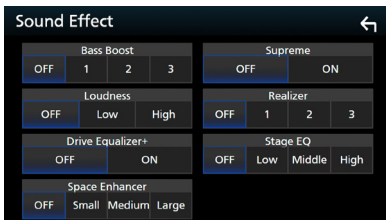

- 4 Set each parameter as follows.**

**■ Bass Boost**

Set the amount of bass boost "OFF"/"1"/"2"/"3".

**■ Loudness**

Set the amount of boost of low and high tones.

"OFF"/"Low"/"High"

**■ Drive Equalizer+**

The sound quality is automatically optimized to meet the current car speed by GPS.

"OFF"/"ON"

**■ Space Enhancer**

Select the feeling of sound space enhancement.

"OFF"/"Small"/"Medium"/"Large".

This setting is not available for the HD Radio tuner source.

**■ Supreme**

Turn ON/OFF the Supreme function.

Technology to extrapolate and supplement with proprietary algorithm, the high-frequency range that is cut off when encoding.

**■ Realizer**

Virtually make the sound more realistic using the Digital Signal Processor (DSP) system.

Select the level from "OFF"/"1"/"2"/"3".

**■ Stage EQ**

You can adjust the height of speakers virtually to suit your listening position.

"OFF"/"Low"/"Middle"/"High".

## Listening Position/ DTA

Listening Position/DTA allows you to improve the sound field depending on the position of the seat you sit.

Listening Position/DTA allows you to set "Listening Position" and "Front Focus". You cannot set both at the same time.

**1** Press the **MENU** button.

➤ Pop up menu appears.

**2** Touch **Audio**.

➤ Audio screen appears.

**3** Touch **Position/DTA**.

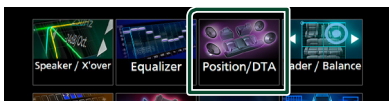

- Set up Listening Position (P.86)
- Set up Front Focus (P.86)

### Listening Position

Adjust the sound delay time so that the sounds from different speakers arrive at the listener sitting on the selected seat at the same time.

**1** Touch **Listening Position** on the Position/DTA screen.

**2** Select a listening position from **Front R** (Right front), **Front L** (Left front), **Front All** (All front), and **All**.



### Position DTA control

You can fine-adjust your listening position.

**1** Touch **Adjust**.

**2** Touch **Delay**.

**3** Touch ◀ or ▶ to adjust the delay time of the selected speaker.

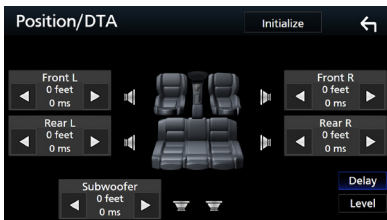

**4** Touch **Level**.

**5** Touch ◀ or ▶ to adjust the sound level of the selected speaker.

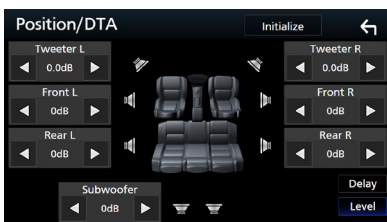

### NOTE

- To initialize the Delay and Level settings, touch **Initialize** and **YES** on the confirmation screen.

### Front Focus

You can focus the imaginary sound image on the front of the selected seat.

**1** Touch **Front Focus** in the Position/DTA screen.

**2** Select a front focus position.

For **Front All** and **All**, select Priority L or R depending on which side you want to put the imaginary sound image.

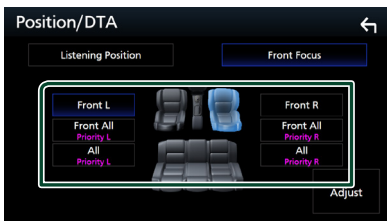

## Front Focus fine adjustment

- 1 Touch **Adjust**.
- 2 Touch **Delay**.
- 3 Set each parameter as follows.

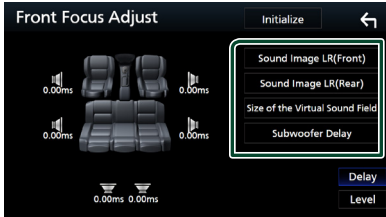

### ■ Sound Image LR (Front)

Focus the sound image on the front of front seats.

### ■ Sound Image LR (Rear)

Focus the sound image on the front of rear seats.

### ■ Size of the Virtual Sound Field

Adjust the size of sound image to meet your taste. If the sound image is shifted from the front, move it back by **Sound Image LR (Front)** or **Sound Image LR (Rear)**.

### ■ Subwoofer Delay

Adjust the delay time of subwoofer sound.

- 4 Touch **Level**.
- 5 Touch **◀** or **▶** to adjust the sound level of the selected speaker.

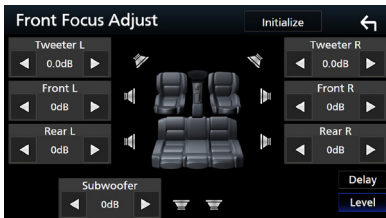

## NOTE

- To initialize the Delay and Level settings, touch **Initialize** and **YES** on the confirmation screen.

## Audio Setup memory

Audio Control settings can be memorized. The memorized settings can be recalled at any time.

- 1 Press the **MENU** button.
  - ▶ Popup menu appears.
- 2 Touch **Audio**.
  - ▶ Audio screen appears.
- 3 Touch **Audio Memory**.

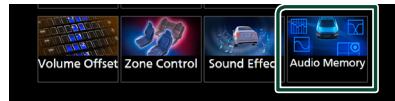

### ■ SETUP Memory

Lock or unlock the Audio SETUP Memory/Recall/Clear.

### ■ Audio SETUP Memory

Memorize the current audio settings.

- Fader/ Balance, Speaker / X'over, Equalizer (User Preset, SW Level), Position/DTA, Sound Effect (**P.81**)

### ■ Audio SETUP Recall

Recall the memorized audio setting.

### ■ Audio SETUP Clear

Clear the AUDIO SETUP Memory and the currently memorized audio settings.

## Remote control

This unit can be operated using the remote control KNA-RCDV331 (optional accessory).

### ⚠ CAUTION

- Put the remote control in a place where it will not move during braking or other operations. A dangerous situation could result, if the remote control falls down and gets wedged under the pedals while driving.
- Do not leave the battery near fire or under direct sunlight. A fire, explosion or excessive heat generation may result.
- Do not recharge, short, break up or heat the battery or place it in an open fire. Such actions may cause the battery to leak fluid. If spilled fluid comes in contact with your eyes or on clothing, immediately rinse with water and consult a physician.
- Place the battery out of reach of children. In the unlikely event that a child swallows the battery, immediately consult a physician.

### Battery Installation

If the remote control operates only over shorter distances or does not operate at all, it is possible that the batteries are depleted.

In such instances, replace the both batteries with new ones.

- 1 Insert two "AAA"/"R03"-size batteries with the ⊕ and ⊖ poles aligned properly, following the illustration inside the case.

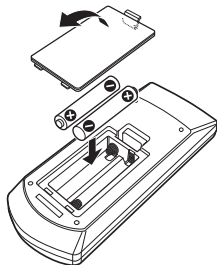

### Functions of the Remote control Buttons

#### ■ Switch the operation mode

The functions operated from the remote control differ depending on the position of the mode switch.

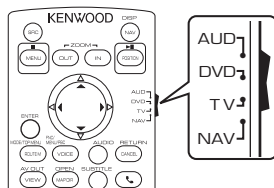

#### ■ AUD mode

Switch to this mode when controlling a selected source or tuner source, etc.

#### ■ DVD mode

Switch to this mode when playing a disc media including DVD, VCD, and CD.

#### ■ NAV mode

Switch to this mode when controlling navigation function.

#### ■ TV mode

Not used.

#### NOTE

- When controlling a player that is not integrated in the unit, select "AUD" mode.

#### ■ Direct search mode

Using the remote control, you can jump directly to the desired file, track chapter, etc. by entering the number corresponding to the content.

#### NOTE

- This operation cannot be performed for the USB device and iPod.

- 1 Press the #BS button several times until the desired content appears.

The available contents are different depending on the source type.

■ DVD

Title number/Chapter number

■ VCD 1.X and 2.X (PBC OFF)

Track number

■ VCD 2.X (PBC ON)

Scene number/Track number

■ Music CD

Track number

■ HD Radio tuner

Frequency value/Channel number

■ SiriusXM

Channel number

**2** Enter the number of the content you want to play using the numeric keypad.

**3** For DVD or VCD, music CD, press the **ENTER** button.

For radio, press the ◀ or ▶ button.

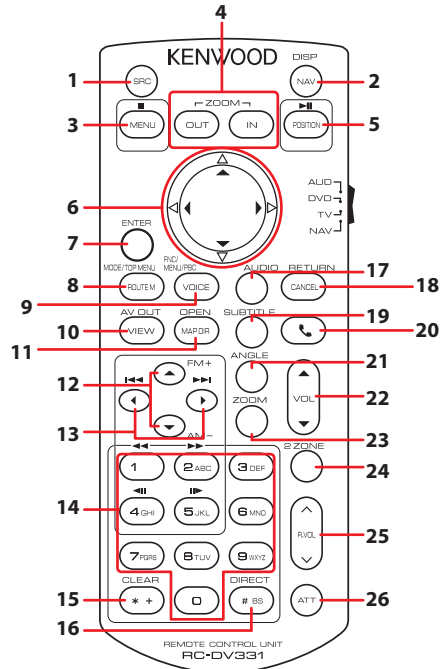

▶ The content corresponding to the number you entered is played.

**Basic Operation**



	Key Name	Mode switch	Function
1	SRC	AUD, DVD	Switches to the source to be played. In hands-free mode, hangs up the phone.
2	NAV	–	Switches the screen between the navigation, the current source and the Weblink screen from the connected iPhone/Android.
3	MENU	DVD	Stops playing and memorizes the last point where the disc stopped. The last point is deleted by pressing twice.
		NAV	Displays Main menu.
4	OUT, IN	NAV	Zooms in or out the navigation map.
5	POSITION	AUD, DVD	Pauses the track or file, and resumes playing by pressing twice. For the radio and HD Radio sources in AUD mode, switches the seek mode.
		NAV	Displays the current position.
6	Cursor Key	DVD	Moves the cursor in the DVD menu.
		NAV	Moves the cursor or scrolls the map.
7	ENTER	–	Performs the selected function.
8	ROUTE M	AUD	Screen mode changes each time you press this key during video playback.
		DVD	Returns to the DVD top menu.
		NAV	Displays Route Option menu.

## Remote control

	Key Name	Mode switch	Function
9	VOICE	AUD	Displays the control screen of current source. (USB, SD, iPod, DISC)
		DVD	Displays the DVD menu. Turns the playback control on or off while playing VCD.
		NAV	Speaks the voice guidance.
10	VIEW	AUD, DVD	Switches the AV source to be output.
		NAV	Switches between 2D and 3D map displays.
11	MAP DIR	AUD, DVD	Switches the display angle each time it is pressed.
		NAV	Switches between the heading up navigation and north up navigation map displays.
12	▲/▼	AUD, DVD	Selects the folder to be played. For the radio and HD Radio sources in AUD mode, selects FM/ AM band to be received. For the SiriusXM source in AUD mode, selects the band to be received. For the DVD/VCD source in DVD mode, selects the title to be played.
13	◀▶	AUD, DVD	Selects the track or file to be played. For the radio, HD Radio, and SiriusXM sources in AUD mode, switches to broadcast stations received by the unit. For the DVD/VCD source in DVD mode, selects the chapter/scene/track to be played.
14	Numeric Keypad	AUD	Allows you to enter the number to search in the direct search mode. For details on the direct search mode, see <b>Direct search mode (P.88)</b> .
		DVD	<ul style="list-style-type: none"> <li>• Press <b>1 2</b> to fast forward/backward.</li> <li>• Press <b>4 5</b> to slow forward/backward. Switches the slow playback speed each time you press this key.*</li> </ul> *DVD only
15	* +	DVD	For the DVD/VCD source, deletes a character while in direct search mode.
16	# BS	AUD, DVD	Switches to the direct search mode. For details on the direct search mode, see <b>Direct search mode (P.88)</b> .
17	AUDIO	DVD	Switches the voice language each time you press this key.
18	CANCEL	DVD	Displays previous screen.
		NAV	Cancels the operations.
19	SUBTITLE	DVD	Switches the subtitle language.
20		–	When a call comes in, answers the call.
21	ANGLE	DVD	Switches the picture angle each time you press this key.
22	Vol ▲▼	–	Adjusts the volume.
23	ZOOM	DVD	Switches the zoom ratio (2, 3, 4, Off) each time you press this key.
24	2 ZONE	AUD, DVD	Switches the Dual Zone function on and off.
25	R.VOL 	–	Adjusts volume at rear when the Dual Zone function is on.
26	ATT	–	Lowers the volume when pressed once. Restores the previous volume when pressed twice.

# Connection/Installation

## Before Installation

Before installation of this unit, please note the following precautions.

### ▲ WARNINGS

- If you connect the ignition wire (red) and the battery wire (yellow) to the car chassis (ground), you may cause a short circuit, that in turn may start a fire. Always connect those wires to the power source running through the fuse box.
- Do not cut out the fuse from the ignition wire (red) and the battery wire (yellow). The power supply must be connected to the wires via the fuse.

### ▲ CAUTION

- Install this unit in the console of your vehicle. Do not touch the metal part of this unit during and shortly after the use of the unit. Metal part such as the heat sink and enclosure become hot.

### NOTE

- Mounting and wiring this product requires skills and experience. For best safety, leave the mounting and wiring work to professionals.
- Make sure to ground the unit to a negative 12V DC power supply.
- Do not install the unit in a spot exposed to direct sunlight or excessive heat or humidity. Also avoid places with too much dust or the possibility of water splashing.
- Do not use your own screws. Use only the screws provided. If you use the wrong screws, you could damage the unit.
- If the power is not turned ON ("There is an error in the speaker wiring. Please check the connections." is displayed), the speaker wire may have a short-circuit or touched the chassis of the vehicle and the protection function may have been activated. Therefore, the speaker wire should be checked.
- If your car's ignition does not have an ACC position, connect the ignition wires to a power source that can be turned on and off with the

ignition key. If you connect the ignition wire to a power source with a constant voltage supply, such as with battery wires, the battery may be drained.

- If the console has a lid, make sure to install the unit so that the front panel will not hit the lid when closing and opening.
- If the fuse blows, first make sure the wires aren't touching to cause a short circuit, then replace the old fuse with one with the same rating.
- Insulate unconnected wires with vinyl tape or other similar material. To prevent a short circuit, do not remove the caps on the ends of the unconnected wires or the terminals.
- Connect the speaker wires correctly to the terminals to which they correspond. The unit may be damaged or fail to work if you share the ⊖ wires or ground them to any metal part in the car.
- When only two speakers are being connected to the system, connect the connectors either to both the front output terminals or to both the rear output terminals (do not mix front and rear). For example, if you connect the ⊕ connector of the left speaker to a front output terminal, do not connect the ⊖ connector to a rear output terminal.
- After the unit is installed, check whether the brake lamps, blinkers, wipers, etc. on the car are working properly.
- Mount the unit so that the mounting angle is 30° or less.
- This unit has the cooling fan to decrease the internal temperature. Do not mount the unit in a place where the cooling fan of the unit is blocked. Blocking these openings will inhibit the cooling of the internal temperature and result in malfunction.

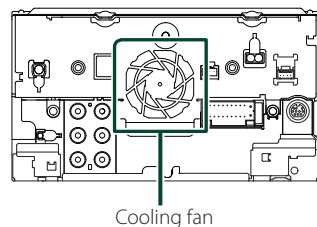



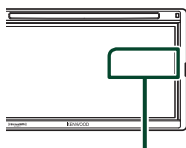

## Connection/Installation



- Do not press hard on the panel surface when installing the unit to the vehicle. Otherwise scars, damage, or failure may result.
- Reception may drop if there are metal objects near the Bluetooth antenna.

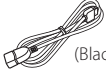

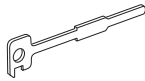
Bluetooth antenna unit

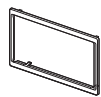
### ■ Supplied accessories for installation

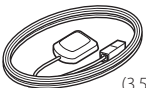
①		x1
②	 (Black 1 m)	x1
③	 (Gray 1 m)	x1
④	 (3 m)	x1
⑤ <sup>[1]</sup>		x2
⑥	 (M5 x 8 mm)	x6
⑦	 (M5 x 8 mm)	x6
⑧ <sup>[1]</sup>		x1

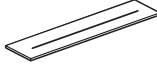
⑨	 (3.5 m)	x1
⑩		x1
⑪ <sup>[1]</sup>		x1
⑫ <sup>[1]</sup>		x4

<sup>[1]</sup> DNX995S only

### ■ Installation procedure

- 1) To prevent a short circuit, remove the key from the ignition and disconnect the ⊖ terminal of the battery.
- 2) Make the proper input and output wire connections for each unit.
- 3) Connect the speaker wires of the wiring harness.
- 4) Connect the wiring harness wires in the following order; ground, battery, ignition.
- 5) Connect the wiring harness connector to the unit.
- 6) Install the unit in your car.
- 7) Reconnect the ⊖ terminal of the battery.
- 8) Perform the Initial Setup.  
See **Initial setup (P.9)**.

## Installing the unit

### Non-Japanese cars (DNX995S)

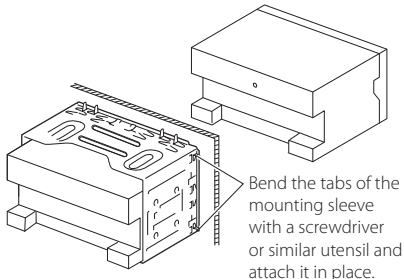

### Japanese cars

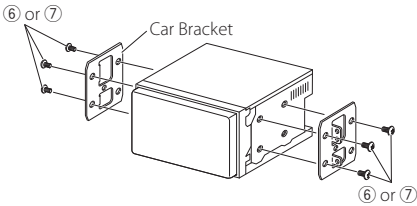

#### NOTE

- Make sure that the unit is installed securely in place. If the unit is unstable, it may malfunction (eg, the sound may skip).

### Trim plate (DNX995S)

- 1) Attach accessory ⑧ to the unit.

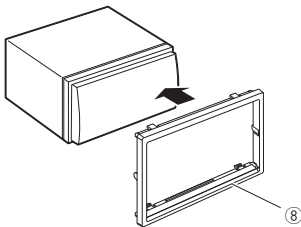

### General Motors cars (DNX995S)

- 1) Cut out accessory ⑪ to meet the shape of the opening of the center console.
- 2) Attach accessory ⑪ to the unit.

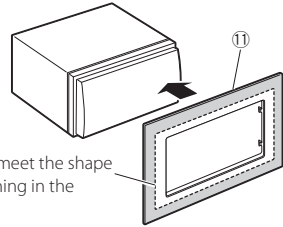

### Toyota/Scion cars (DNX995S)

- 1) Cut out accessory ⑪ as illustrated.

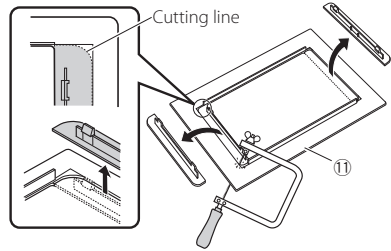

- 2) Fold double-sided adhesive (accessory ⑫) along the slit and attach it to accessory ⑪ cut-out against the center rib as illustrated. Use 2 pieces of accessory ⑫ for 1 accessory ⑪ cut-out.
- 3) Attach accessory ⑪ cut-out to the unit.

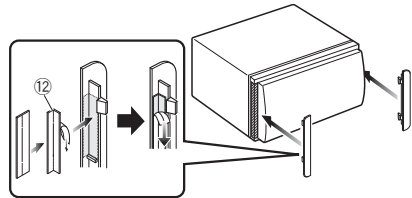

### GPS antenna

GPS antenna is installed inside of the car. It should be installed as horizontally as possible to allow easy reception of the GPS satellite signals.

To mount the GPS antenna inside your vehicle:

- 1) Clean your dashboard or other surface.
- 2) Remove the separator of the metal plate (accessory ⑩).
- 3) Press the metal plate (accessory ⑩) down firmly on your dashboard or other mounting surface. You can bend the metal plate (accessory ⑩) to conform to a curved surface, if necessary.
- 4) Remove the separator of the GPS antenna (accessory ⑨), and stick the antenna to the metal plate (accessory ⑩).

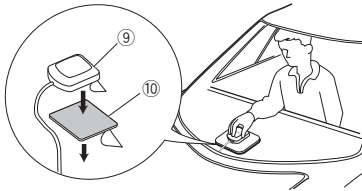

#### NOTE

- Depending on the type of car, reception of the GPS satellite signals might not be possible with an inside installation.
- Please install this GPS antenna in an area away from any antennas that are used with CB radios or satellite televisions.
- The GPS antenna should be installed at a position that is spaced at least 12 inch (30 cm) from cellular phone or other transmitting antennas. Signals from the GPS satellite may be interfered with by these types of communication.
- Painting the GPS antenna with (metallic) paint may cause a drop in performance.

### Microphone unit

- 1) Check the installation position of the microphone (accessory ④).
- 2) Clean the installation surface.
- 3) Remove the separator of the microphone (accessory ④), and stick the microphone to the place shown below.
- 4) Wire the microphone cable up to the unit with it secured at several positions using tape or other desired method.
- 5) Adjust the direction of the microphone (accessory ④) to the driver.



Fix a cable with a commercial item of tape.

## ■ Removing the trim plate (DNX995S)

- 1) Engage the catch pins on the extraction key (accessory ⑤) and remove the two locks on the lower level.  
Lower the trim plate (accessory ⑧) and pull it forward as shown in the figure.

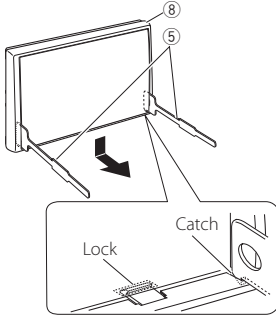

### NOTE

- The trim plate can be removed from the top side in the same manner.

- 2) When the lower level is removed, remove the upper two locations.

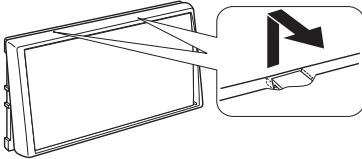

## ■ Removing the unit (DNX995S)

- 1) Remove the trim plate by referring to step 1 in "Removing the trim plate".
- 2) Insert the two extraction keys (accessory ⑤) deeply into the slots on each side, as shown.

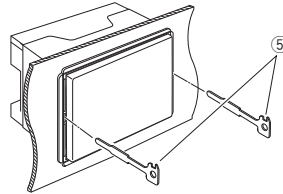

- 3) Lower the extraction key toward the bottom, and pull out the unit halfway while pressing towards the inside.

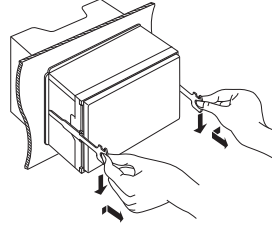

### NOTE

- Be careful to avoid injury from the catch pins on the extraction key.

- 4) Pull the unit all the way out with your hands, being careful not to drop it.

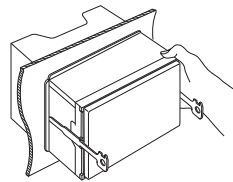

## Connecting wires to terminals

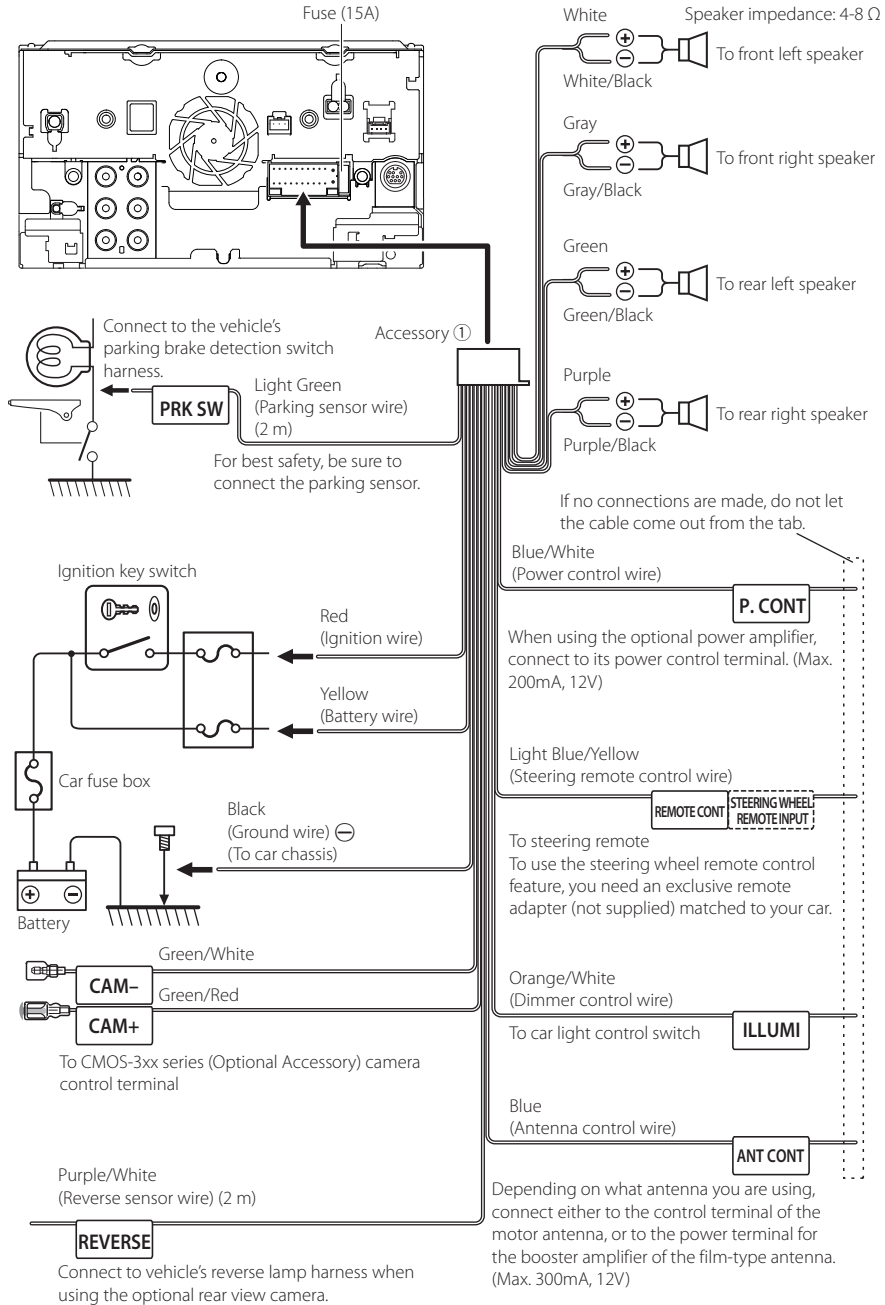

## Connecting the system and external components

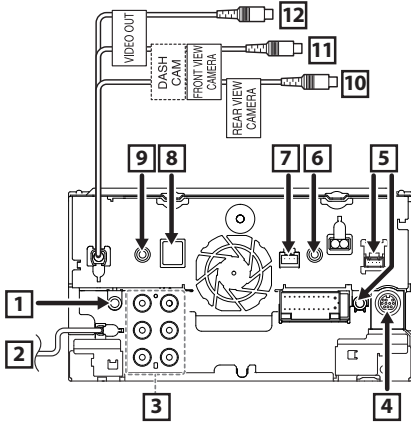

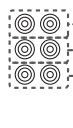
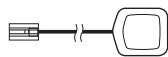
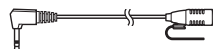
<b>1</b>	AV Audio output (ø3.5 mini jack)
<b>2</b>	FM/AM antenna input 
<b>3</b>	When connecting to an external amplifier, connect its ground wire to the car's chassis to avoid damaging the unit.  <div style="display: flex; align-items: center;"> <div style="margin-right: 10px;"> <p>--- Rear Audio Preout (Left; White, Right; Red)</p> <p>--- Front Audio Preout (Left; White, Right; Red)</p> <p>--- Subwoofer Preout (Left; White, Right; Red)</p> </div>  </div>
<b>4</b>	SiriusXM Connect Vehicle Tuner connector For more information on how to install the SiriusXM Connect Vehicle tuner, consult the installation guide included with the tuner.
<b>5</b>	iDatalink connector
<b>6</b>	AV-IN (CA-C3AV; Optional Accessory) input
<b>7</b>	Dashboard camera interface Connect a Dashboard Camera DRV-N520 (optional accessory). <b>(P.98)</b>
<b>8</b>	Accessory 9: GPS Antenna 
<b>9</b>	Accessory 4: Bluetooth Microphone 

<b>10</b>	Rear view camera input (Yellow)
<b>11</b>	Front view camera/ Dashboard camera input (Yellow)
<b>12</b>	Visual Output (Yellow)

## Connecting a USB device

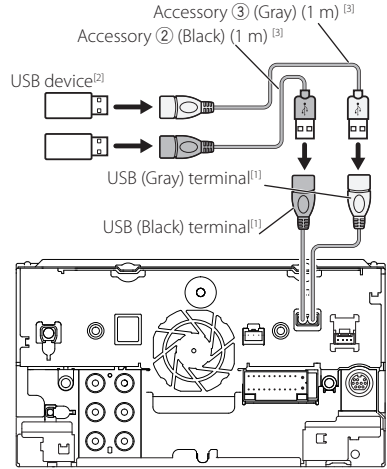

<sup>[1]</sup> USB maximum power supply current : DC 5 V  $\bar{\bar{=}}$  1.5 A

<sup>[2]</sup> Sold separately / Use CA-U1EX to extend the cable if necessary. (Max 500 mA, 5V)

<sup>[3]</sup> See **Securing the USB extension cable (P.97)**.

## Securing the USB extension cable

Secure the USB extension cable with insulating tape or the like so that its connectors are not disconnected.

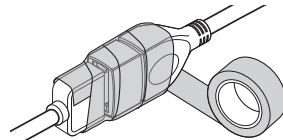

## Connecting an iPod/iPhone

### ● Lightning connector

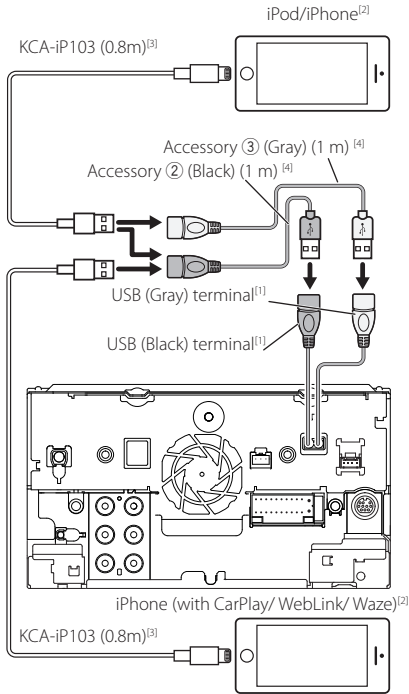

<sup>[1]</sup> USB maximum power supply current :  
DC 5 V  $\overline{\text{---}}$  1.5 A

<sup>[2]</sup> Sold separately

<sup>[3]</sup> Optional accessory

<sup>[4]</sup> See **Securing the USB extension cable (P.97)**.

## Connecting an Android smartphone

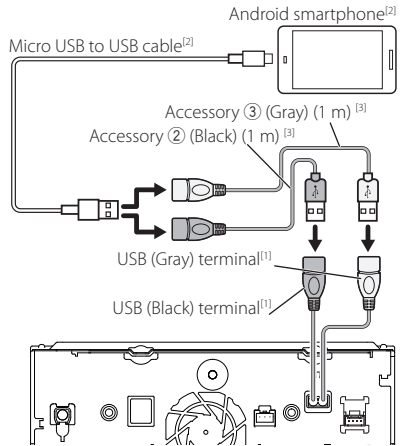

<sup>[1]</sup> USB maximum power supply current :  
DC 5 V  $\overline{\text{---}}$  1.5 A

<sup>[2]</sup> Sold separately

<sup>[3]</sup> See **Securing the USB extension cable (P.97)**.

## Connecting a Dashboard camera

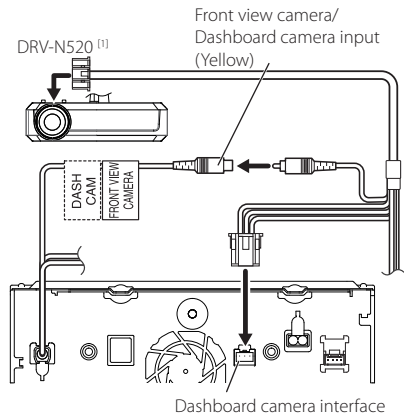

<sup>[1]</sup> Optional accessory

# Troubleshooting

## Problems and Solutions

If any trouble occurs, first check the following table for possible problems.

### NOTE

- Some functions of this unit may be disabled by some settings made on this unit.
- What might seem to be a malfunction in your unit may just be the result of slight misoperation or miswiring.

### About settings

- **Cannot set up the subwoofer.**
- **Cannot set up subwoofer phase.**
- **No output from the subwoofer.**
- **Cannot set up the low pass filter.**
- **Cannot set up the high pass filter.**

Subwoofer is not set to on.

- Set the subwoofer to on. See *Speaker/X'over setup (P.81)*.

The dual zone function is enabled.

- Set the dual zone function to off. See *Zone Control (P.84)*.

- **Cannot select the output destination of the subsource in the dual zone.**
- **Cannot adjust the volume of the rear speakers.**

The dual zone function is disabled.

- Set the dual zone function to on. See *Zone Control (P.84)*.

- **Cannot set up the equalizer.**
- **Cannot set up the crossover network.**

The dual zone function is enabled.

- Set the dual zone function to off. See *Zone Control (P.84)*.

### About audio operations

#### Radio reception is poor.

The car antenna is not extended.

- Pull out the antenna all the way.

The antenna control wire is not connected.

- Connect the wire correctly. See *Connecting the system and external components (P.97)*.

#### Cannot select a folder.

The random play function is enabled.

- Turn off the random function.

#### Cannot perform repeat play during VCD playback.

The PBC function is enabled.

- Turn off the PBC function.

#### The specified disc does not play, but another one plays instead.

The disc is quite dirty.

- Clean the disc. See *Precautions on handling discs (P.4)*.

The disc is severely scratched.

- Try another disc instead.

#### The sound skips when an audio file is being played.

The disc is scratched or dirty.

- Clean the disc. See *Precautions on handling discs (P.4)*.

The recording condition is bad.

- Record the file again or use another disc.

### Others

#### The Touch Sensor Tone doesn't sound.

The preout jack is being used.

- The Touch Sensor Tone cannot be output from the preout jack.

#### Android smartphone operation is slow.

This occurs when multiple applications are started on the Android smartphone.

- For details, see *Caution for Smartphone Users (P.5)*.

## Error Messages

When you fail to operate the unit correctly, the cause of the failure appears as the message on the screen.

#### There is an error in the speaker wiring. Please check the connections.

Protective circuit has been activated because a speaker cord has shorted or it has come in contact with the car chassis.

- Wire or insulate the speaker cord as appropriate and turn the power off and on again.

#### Hot Error

When the internal temperature of this unit rises to 60°C or more, the protection circuit is activated and you may not be able to operate the unit.

- Use the unit again after reducing the temperature of the unit.

#### Mecha Error

The disc player is malfunctioning.

- Eject the disc and try inserting it again. Contact the KENWOOD dealer if this indicator continues blinking or the disc cannot be ejected.

## Troubleshooting

---

### Disc Error

An unplayable disc is inserted.

- Change the disc. See **Playable Media and Files (P.101)**.

---

### Read Error

The disc is quite dirty.

- Clean the disc. See **Precautions on handling discs (P.4)**.

Disc is upside down.

- Load the disc with the labeled side up.

---

### Region Code Error

The disc you wanted to play has a region code that cannot be played with this unit.

- See **Region Codes in the World (P.103)** or try another disc.

---

### Error 07–67

The unit is not operating correctly due to some reason or other.

- Turn the power off and on again. If the “Error 07–67” message does not disappear, contact your nearest KENWOOD dealer.

---

### No Device (USB device)

The USB device is selected as a source although no USB device is connected.

- Change the source to any source other than USB/iPod. Connect a USB device, and change the source to USB again.

---

### Disconnected (iPod, Bluetooth audio player)

The iPod/Bluetooth audio player is selected as a source although no iPod/Bluetooth audio player is connected.

- Change the source to any source other than iPod/Bluetooth. Connect an iPod/Bluetooth audio player, and change the source to iPod/Bluetooth again.

---

### No Media file

The connected USB device contains no playable audio file. Media was played that doesn't have data recorded that the unit can play.

- See **Playable Media and Files (P.101)** and try another USB device.

---

### USB device over current status detected.

The connected USB device is rated a current capacity higher than the allowable limit.

- Check the USB device. Some trouble may have occurred to the connected USB device.
- Change the source to any source other than USB. Remove the USB device.

---

### Navigation Error. Please turn on power again later.

The communication error has occurred due to severely cold temperature.

- Turn on power again after warming your car interior.

---

## SiriusXM

---

### Check Tuner

A SiriusXM tuner is not connected to this unit.

- Verify that the SiriusXM Connect Vehicle Tuner cable is securely connected to the radio.

---

### Subscription Updated - Press Return To Continue

The SiriusXM subscription has been renewed.

- Pressing the Control knob will clear the message.

---

### SXM Chan Unavailable

The currently selected channel is unavailable.

- Visit [www.siriusxm.com](http://www.siriusxm.com) for more information about the SiriusXM channel lineup.

---

### SXM Ch Unsubscribed

The currently selected channel is not subscribed to.

- In the U.S.A., visit [www.siriusxm.com](http://www.siriusxm.com) or call 1-866-635-2349 if you have questions about your subscription package or would like to subscribe to this channel.
- In Canada, visit [www.siriusxm.ca](http://www.siriusxm.ca) or call 1-877-438-9677.

---

### SXM Check Antenna

No antenna is connected to the SiriusXM tuner.

- Check that an antenna is connected to the SiriusXM tuner. Check antenna for damages.

---

### SXM No Signal

No SiriusXM radio signal is received.

- Verify that your vehicle is outdoors with a clear view of the sky.

---

### Channel Locked

The selected channel has been locked by the parental controls.

- Enter the unlock code when you are asked. See **Parental Control (P.55)**.

---

### Incorrect Pass Code entered

The selected channel is a mature or parental lock channel, and locked by the parental lock or user lock code.

- Enter the correct lock code.

# Appendix

## Playable Media and Files

You can play various kinds of media and files on this unit.

### List of playable discs

Disc types / Standard		Support	Remark
DVD	DVD Video	○	
	DVD Audio	×	
	DVD-VR	×	
	DVD-R*1	○	<ul style="list-style-type: none"> <li>• MP3/ WMA/ AAC/ WAV/ FLAC/ Vorbis/ MPEG1/ MPEG2/ MPEG4/ H.264/ WMV/ MKV playback</li> <li>• Multi-border/Multisession playback (Playback depends on authoring conditions)</li> </ul>
	DVD-RW	○	
	DVD+R	○	
	DVD+RW	○	
	DVD-R DL (Dual layer)	○	Only video format
DVD+R DL (Double layer)	○		
DVD-RAM	×		
CD	Music CD*1	○	
	CD-ROM	○	<ul style="list-style-type: none"> <li>• MP3/ WMA/ AAC/ WAV/ FLAC/ Vorbis playback</li> <li>• Multisession is supported.</li> <li>• Packet write is not supported.</li> </ul>
	CD-R	○	
	CD-RW	○	
	DTS-CD	×	
	Video CD (VCD)	○	
	Super video CD	×	
	Photo CD	×	
	CD-EXTRA	△	Only music CD session can be played.
	HDCD	△	Normal music CD sound quality
	CCCD	×	
Others	Dualdisc	×	
	Super audio CD	△	Only CD layer can be played.

○ : Playback is possible.

△ : Playback is partly possible.

×

\*1 Incompatible with 8 cm (3 inch) discs.

### Use of DualDisc

When playing a "DualDisc" on this unit, the surface of the disc that is not played may be scratched while the disc is inserted or ejected. Since the music CD surface does not conform to the CD standard, playback may be impossible.

(A "DualDisc" is a disc with one surface containing DVD standard signals and the other surface containing music CD signals.)

### About disc format

The disc format should be the one of the following.

- ISO 9660 Level 1/2
- Joliet
- Romeo
- Long file name

## About files

The following audio and video files are supported.

### ■ Playable Audio files

	Format	Bit rate	Sampling frequency	Bit count
AAC-LC (.m4a)	MPEG2/4 AAC LC HE-AAC(V1,V2)	8 – 320kbps, VBR	16 – 48 kHz	16 bit
MP3 (.mp3)	MPEG 1/2 Audio Layer 3	8 – 320kbps, VBR	16 – 48 kHz	16 bit
WMA (.wma)	Windows Media Audio Standard L3 profile (Version 7,8,9)	8 – 320kbps	16 – 48 kHz	16 bit
Linear PCM (WAVE) (.wav)	RIFF waveform Audio Format	–	16 – 48 kHz (Disc), 16 – 192 kHz (USB/ SD)	16/ 24 bit
FLAC (.flac)	flac	–	16 – 48 kHz (Disc), 16 – 192 kHz (USB/ SD)	16/ 24 bit
Vorbis (.ogg)	vorbis	VBR	16 – 48 kHz	16 bit
DSD (.dsf, .dff)	DSF, DSDIFF	–	2.8 MHz, 5.6 MHz, 11.2 MHz	1 bit

- If music of normal CD and other playback systems are recorded in the same disc, only the playback system recorded at the first setout is played.
- WMA and AAC files with DRM cannot be played.
- DSD sound is converted to PCM sound before playback.
- The EmChinks tag of DSDIFF is not supported.
- Although the audio files complies with the standards listed above, they may not be played depending on the types or conditions of media or device.
- This unit supports playback of High-Resolution Audio files.  
It is recommended that a car audio system should be configured with all High-Resolution Audio compatible products from player to speaker to enjoy its high quality sound.

### ■ Acceptable Video files

	Profile	Max. Picture size	Max. bit rate	Audio format
MPEG-1 (.mpg, .mpeg)	–	352 × 240, 352 × 288	1.5 Mbps	MPEG Audio Layer 2
MPEG-2 (.mpg, .mpeg)	MP@ML	720 × 480, 720 × 576	8 Mbps	MPEG Audio Layer 2
H.264/MPEG-4 AVC (.mp4, .m4v, .avi, .flv, .f4v)	Baseline Profile, Main Profile	1920 × 1080 (30 fps)	8 Mbps	MP3, AAC
MPEG-4 (.mp4, .avi)	Advanced Simple Profile	1920 × 1080 (30 fps)	8 Mbps	MP3, AAC
WMV (.wmv)	Main Profile	1920 × 1080 (30 fps)	8 Mbps	WMA
MKV (.mkv)	Video format follows H.264/MPEG-4 AVC, MPEG-4, WMV			MP3, AAC, WMA, Vorbis, FLAC

- This unit can only play back files which are smaller than 4 GB.

### ■ Limitation on structure of file and folder

	Disc media	USB device/ SD
Maximum number of folder layers	8	8
Maximum number of files (per folder)	999	999
Maximum number of folders (per folder)	5000	9999
Maximum number of folders (per device)	5000	Unlimited

- You can enter a folder name and file name with 255 or fewer single-byte characters.
- Files in the folder whose folder name begins with a dot (.) cannot be played.

## Region Codes in the World

The DVD players are given a region code according to the country or area it is marketed, as shown in the following map.

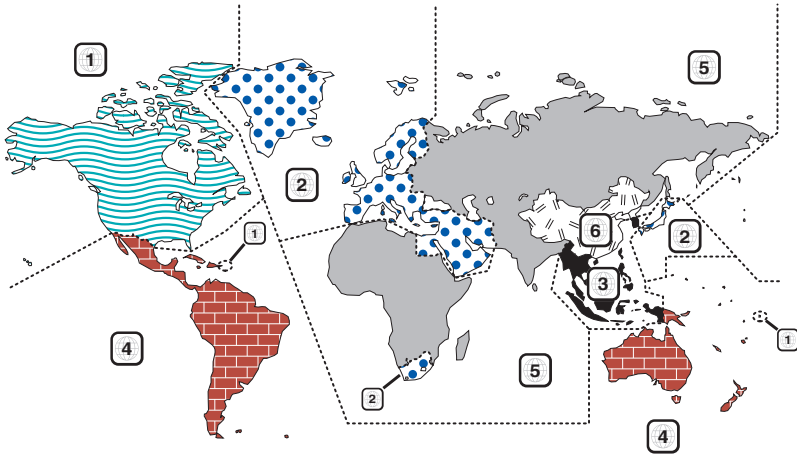

### ■ DVD disc marks



Indicates a region number. The discs with this mark can be played with any DVD player.



Indicates the number of audio languages recorded. Up to 8 languages can be recorded in a movie. You can select a favorite language.



Indicates the number of subtitled languages recorded. Up to 32 languages can be recorded.



If a DVD disc has scenes shot from multiple angles, you can select a favorite angle.



Indicates the type of screen for the image. The left mark indicates that a wide image picture (16:9) is displayed on a standard TV set screen (4:3) with a black band at both the top and bottom of the screen (letter box).

### ■ Operation regulatory marks

With this DVD, some functions of this unit such as the play function may be restricted depending on the location where the DVD is playing. In this case, the following marks will appear on the screen. For more information, refer to the disc manual.



### ■ Discs with limited period of use

Do not leave discs with a limited period of use in this unit. If you load an already expired disc, you may not be able to remove it from this unit.

## DVD Language Codes

Code	Language
aa	Afar
ab	Abkhazian
af	Afrikaans
am	Amharic
ar	Arabic
as	Assamese
ay	Aymara
az	Azerbaijani
ba	Bashkir
be	Byelorussian
bg	Bulgarian
bh	Bihari
bi	Bislama
bn	Bengali, Bangla
bo	Tibetan
br	Breton
ca	Catalan
co	Corsican
cs	Czech
cy	Welsh
da	Danish
de	German
dz	Bhutani
el	Greek
en	English
eo	Esperanto
es	Spanish
et	Estonian
eu	Basque
fa	Persian
fi	Finnish
fj	Fiji
fo	Faroese
fr	French
fy	Frisian
ga	Irish
gd	Scots Gaelic
gl	Galician
gn	Guarani
gu	Gujarati
ha	Hausa
he	Hebrew
hi	Hindi
hr	Croatian
hu	Hungarian
hy	Armenian

Code	Language
ia	Interlingua
ie	Interlingue
ik	Inupiak
id	Indonesian
is	Icelandic
it	Italian
ja	Japanese
jv	Javanese
ka	Georgian
kk	Kazakh
kl	Greenlandic
km	Cambodian
kn	Kannada
ko	Korean
ks	Kashmiri
ku	Kurdish
ky	Kirghiz
la	Latin
lb	Luxembourgish
ln	Lingala
lo	Laotian
lt	Lithuanian
lv	Latvian, Lettish
mg	Malagasy
mi	Maori
mk	Macedonian
ml	Malayalam
mn	Mongolian
mo	Moldavian
mr	Marathi
ms	Malay
mt	Maltese
my	Burmese
na	Nauru
ne	Nepali
nl	Dutch
no	Norwegian
oc	Occitan
om	(Afan) Oromo
or	Oriya
pa	Punjabi
pl	Polish
ps	Pashto, Pushto
pt	Portuguese
qu	Quechua
rm	Rhaeto-Romance

Code	Language
rn	Kirundi
ro	Romanian
ru	Russian
rw	Kinyarwanda
sa	Sanskrit
sd	Sindhi
sg	Sangho
sh	Serbo-Croatian
si	Singhalese
sk	Slovak
sl	Slovenian
sm	Samoan
sn	Shona
so	Somali
sq	Albanian
sr	Serbian
ss	Siswati
st	Sesotho
su	Sundanese
sv	Swedish
sw	Swahili
ta	Tamil
te	Telugu
tg	Tajik
th	Thai
ti	Tigrinya
tk	Turkmen
tl	Tagalog
tn	Setswana
to	Tongan
tr	Turkish
ts	Tsonga
tt	Tatar
tw	Twi
uk	Ukrainian
ur	Urdu
uz	Uzbek
vi	Vietnamese
vo	Volapuk
wo	Wolof
xh	Xhosa
yo	Yoruba
zh	Chinese
zu	Zulu

## Specifications

### ■ Monitor section

#### Picture Size

- DNX9955
  - : 6.75 inches (diagonal) wide
  - : 152.1 mm (W) × 79.5 mm (H)
  - 5-63/64 × 3-1/8 inch
- DNX8755
  - : 6.95 inches (diagonal) wide
  - : 156.6 mm (W) × 81.6 mm (H)
  - 6-3/16 × 3-3/16 inch

#### Display System

- DNX9955: AAS LCD panel
- DNX8755: TN LCD panel

#### Drive System

- : TFT active matrix system

#### Number of Pixels

- DNX9955
  - : 2,764,800 (1280H x 720V x RGB)
- DNX8755
  - : 1,152,000 (800H x 480V x RGB)

#### Effective Pixels

- : 99.99 %

#### Pixel Arrangement

- : RGB striped arrangement

#### Back Lighting

- : LED

### ■ DVD player section

#### D/A Converter

- : 24/ 32 bit

#### Audio Decoder

- : Linear PCM/ Dolby Audio/ MP3/ WMA/ AAC/ WAV/ FLAC/ Vorbis

#### Video Decoder

- : MPEG1/ MPEG2/ MPEG4/ WMV/ H.264/ MKV

#### Wow & Flutter

- : Below Measurable Limit

#### Frequency Response

- 96 kHz : 20 – 44,000 Hz
- 48 kHz : 20 – 22,000 Hz
- 44.1 kHz : 20 – 20,000 Hz

#### Total Harmonic Distortion

- : 0.010 % (1 kHz)

#### S/N Ratio (dB)

- : 90.5 dB

#### Dynamic Range

- : 89 dB

#### Disc Format

- : DVD-Video/ VIDEO-CD/ CD-DA

#### Quantifying Bit Number

- : 16/ 20/ 24 bit

### ■ USB interface section

#### USB Standard

- : USB 2.0 High Speed

#### File System

- : FAT 16/ 32, exFAT, NTFS

#### Maximum Power Supply Current

- : DC 5 V  1.5 A × 2

#### D/A Converter

- : 24/ 32 bit

#### Audio Decoder

- : MP3/ WMA/ AAC/ WAV/ FLAC/ Vorbis/ DSD

#### Video Decoder

- : MPEG1/ MPEG2/ MPEG4/ WMV/ H.264/ MKV

### ■ SD section

#### SD Standard

- : SD / SDHC / SDXC

#### Compatible File System

- : FAT 16/ 32, exFAT, NTFS

#### Capacity

- : Maximum 2T Byte

#### Data Transfer Rate

- : Maximum 25 Mbps

#### Audio Decoder

- : MP3/ WMA/ AAC/ WAV/ FLAC/ Vorbis/ DSD

#### Video Decoder

- : MPEG1/ MPEG2/ MPEG4/ WMV/ H.264/ MKV

### ■ Wi-Fi section

#### IEEE Standard

- : 802.11 a/b/g/n

#### Frequency Range

- : Dual Band ( 2.4GHz / 5GHz )

#### Channels

- : Auto(1-11ch) / Auto(149,153,157,161ch)

#### Transfer rates (MAX)

- : 11a:54 Mbps / 11b: 11 Mbps / 11g: 54 Mbps / 11n:150 Mbps

## Appendix

### ■ Bluetooth section

#### Technology

: Bluetooth Ver.4.1

#### Frequency

: 2.402 – 2.480 GHz

#### Output Power

: Power Class2

#### Maximum Communication range

: Line of sight approx. 10m (32.8 ft)

#### Audio Codec

: SBC/ AAC

#### Profile (Multi Profile support)

- HFP (V1.7) (Hands Free Profile)
- SPP (Serial Port Profile)
- A2DP (Advanced Audio Distribution Profile)
- AVRCP (V1.6) (Audio/Video Remote Control Profile)
- PBAP (Phonebook Access Profile)

### ■ DSP section

#### Graphics equalizer

Band: 13 Band

Frequency (BAND1 – 13)

: 62.5/ 100/ 160/ 250/ 400/ 630/ 1k/ 1.6k/ 2.5k/ 4k/  
6.3k/ 10k/ 16k Hz

#### Gain

: -9/-8/-7/-6/-5/-4/-3/-2/-1/0/1/2/3/4/5/6/7/8/9 dB

#### 2Way X'Over

##### High pass filter

Frequency: Through, 30/ 40/ 50/ 60/ 70/ 80/ 90/ 100/  
120/ 150/ 180/ 220/ 250 Hz

Slope: -6/-12/-18/-24 dB/Oct.

##### Low pass filter

Frequency: 30/ 40/ 50/ 60/ 70/ 80/ 90/ 100/ 120/  
150/ 180/ 220/ 250 Hz, Through

Slope: -6/-12/-18/-24 dB/Oct.

#### Position

##### Front / Rear /Subwoofer Delay

: 0 – 20.01 ft (0.03 or 0.04 ft Step)

##### Gain

: -8 – 0 dB

#### Subwoofer level

: -50 – +10 dB

### ■ Digital FM tuner section

#### Frequency Range (step)

: 87.9 MHz – 107.9 MHz (200 kHz)

#### Frequency Response ( $\pm 3.0$ dB)

: 20 Hz – 20 kHz

#### S/N Ratio

: 80 dB (STEREO)

### ■ Digital AM tuner section

#### Frequency Range (step)

: 530 kHz – 1700 kHz (10 kHz)

#### Frequency Response ( $\pm 3.0$ dB)

: 40 Hz – 15 kHz

#### S/N Ratio (dB)

: 80 dB (STEREO)

### ■ FM tuner section

#### Frequency Range (step)

: 87.9 MHz – 107.9 MHz (200 kHz)

#### Usable Sensitivity (S/N : 30 dB)

: 9.3 dBf (0.8  $\mu$ V/ 75  $\Omega$ )

#### Quieting Sensitivity (S/N : 46 dB)

: 10.2 dBf (1.13  $\mu$ V/ 75  $\Omega$ )

#### Frequency Response

: 30 Hz – 15 kHz

#### S/N Ratio (dB)

: 75 dB (MONO)

#### Selectivity ( $\pm 400$ kHz)

: Over 80 dB

#### Stereo Separation

: 45 dB (1 kHz)

### ■ AM tuner section

#### Frequency Range (step)

: 530 kHz – 1700 kHz (10 kHz)

#### Usable Sensitivity

: 28 dB $\mu$

## ■ Video section

Color System of External Video Input  
: NTSC

External Video Input Level (mini jack)  
: 1 Vp-p/ 75  $\Omega$

External Audio Max Input Level (mini jack)  
: 2 V/ 25 k $\Omega$

Video Input Level (RCA jacks)  
: 1 Vp-p/ 75  $\Omega$

Video Output Level (RCA jacks)  
: 1 Vp-p/ 75  $\Omega$

Audio Output Level (mini jack)  
: 1.2 V/ 10 k $\Omega$

## ■ Audio section

Maximum Power (Front & Rear)  
: 50 W  $\times$  4

Typical Power Output (Front & Rear)  
Full Bandwidth Power (at less than 1% THD)  
: 22 W  $\times$  4

Output frequency band  
: 20 – 88,000 Hz

Preout Level (V)  
DNX995S  
: 5 V/ 10 k $\Omega$   
DNX875S  
: 4 V/ 10 k $\Omega$

Preout Impedance  
:  $\leq$  300  $\Omega$

Speaker Impedance  
: 4 – 8  $\Omega$

## ■ Navigation section

Receiver  
: High-sensitivity GPS receiver

Reception Frequency  
: 1575.42 MHz (C/A code)

Acquisition Times  
Cold : 29 seconds (typ)  
(All satellites at -130 dBm Without aiding)

Update Rate  
: 1/second, continuous

Accuracy  
Position: <2.5 meters, CEP, at -130 dBm  
Velocity: 0.1 meter/sec

Position Method  
: GPS

Antenna  
: External GPS antenna

## ■ General

Operating Voltage  
: 14.4 V (10.5 – 16 V allowable)

Maximum Current Consumption  
: 15 A

Installation Dimensions (W  $\times$  H  $\times$  D)  
: 178  $\times$  100  $\times$  160 mm  
7  $\times$  3-15/16  $\times$  6-5/16 inch  
With Sleeve (DNX995S)  
: 182  $\times$  112  $\times$  163 mm  
7-3/16  $\times$  4-7/16  $\times$  6-7/16 inch

Operational Temperature Range  
: -10  $^{\circ}$ C – +60  $^{\circ}$ C

Weight  
: 2.5 kg (5.5 lbs)

### NOTE

- Although the effective pixels for the liquid crystal panel is given as 99.99% or more, 0.01% of pixels may not light or may light incorrectly.

**Specifications subject to change without notice.**

## About this Unit

### ■ Copyrights

- The Bluetooth® word mark and logos are registered trademarks owned by Bluetooth SIG, Inc. and any use of such marks by JVC KENWOOD Corporation is under license. Other trademarks and trade names are those of their respective owners.
- Manufactured under license from Dolby Laboratories. Dolby, Dolby Audio and the double-D symbol are trademarks of Dolby Laboratories.
-  is a trademark of DVD Format/Logo Licensing Corporation registered in the U.S., Japan and other countries.
- This item incorporates copy protection technology that is protected by U.S. patents and other intellectual property rights of Rovi Corporation. Reverse engineering and disassembly are prohibited.
- Microsoft and Windows Media are either registered trademarks or trademarks of Microsoft Corporation in the United States and/or other countries.
- This software is based in part on the work of the independent JPEG Group.
- The "AAC" logo is a trademark of Dolby Laboratories.
- "Made for iPod" and "Made for iPhone" mean that an electronic accessory has been designed to connect specifically to iPod, or iPhone, respectively, and has been certified by the developer to meet Apple performance standards. Apple is not responsible for the operation of this device or its compliance with safety and regulatory standards. Please note that the use of this accessory with iPod, or iPhone may affect wireless performance.
- iPhone, iPod, and iPod touch are trademarks of Apple Inc., registered in the U.S. and other countries.
- Use of the Apple CarPlay logo means that a vehicle user interface meets Apple performance standards. Apple is not responsible for the operation of this vehicle or its compliance with safety and regulatory standards. Please note that the use of this product with iPhone, or iPod may affect wireless performance. Apple CarPlay and Apple CarPlay logo are trademarks of Apple Inc.
- Apple, Siri is a trademark of Apple Inc., registered in the U.S. and other countries. Lightning is a trademark of Apple Inc.
- Sirius, XM and all related marks and logos are trademarks of Sirius XM Radio Inc. All rights reserved.
- HD Radio Technology manufactured under license from iBiquity Digital Corporation. U.S. and Foreign Patents. HD Radio™ and the HD, HD Radio, and "Arc" logos are proprietary trademarks of iBiquity Digital Corp.
- INRIX is a registered trademark of INRIX, Inc.
- Pandora, the Pandora logo, and the Pandora trade dress are trademarks or registered trademarks of Pandora Media, Inc., used with permission.
- SPOTIFY and the Spotify logo are among the

registered trademarks of Spotify AB.

- Android, Android Auto, Google Play and other marks are trademarks of Google LLC.
- WebLink™ is a trademark of Abalta Technologies, Inc.
- Waze and Waze logo are registered trademarks of Google LLC.
- YouTube and the YouTube logo are registered trademarks of Google LLC.
- This License does not grant permission to use the trade names, trademarks, service marks, or product names of the Licensor (Abalta Technologies, Inc.), except as required for reasonable and customary use in describing the origin of the \*\*WEBLINK Product\*\*.
- BlackBerry®, RIM®, Research In Motion® and related trademarks, names and logos are the property of Research In Motion Limited and are registered and/ or used in the U.S. and countries around the world. Used under license from Research In Motion Limited.
- SDXC Logo is a trademark of SD-3C LLC.
- Wi-Fi® is a registered trademark of Wi-Fi Alliance®.
- The Wi-Fi CERTIFIED™ Logo is a certification mark of Wi-Fi Alliance®.
- This product includes FontAvenue® fonts licenced by NEC Corporation. FontAvenue is a registered trademark of NEC Corporation.



- This product includes "Ubiquitous QuickBoot TM" technology developed by Ubiquitous Corp. Ubiquitous QuickBoot TM is a trademark of Ubiquitous Corp. Copyright© 2017 Ubiquitous Corp. All rights reserved.



- THIS PRODUCT IS LICENSED UNDER THE AVC PATENT PORTFOLIO LICENSE FOR THE PERSONAL USE OF A CONSUMER OR OTHER USES IN WHICH IT DOES NOT RECEIVE REMUNERATION TO (i) ENCODE VIDEO IN COMPLIANCE WITH THE AVC STANDARD ("AVC VIDEO") AND/OR (ii) DECODE AVC VIDEO THAT WAS ENCODED BY A CONSUMER ENGAGED IN A PERSONAL ACTIVITY AND/OR WAS OBTAINED FROM A VIDEO PROVIDER LICENSED TO PROVIDE AVC VIDEO. NO LICENSE IS GRANTED OR SHALL BE IMPLIED FOR ANY OTHER USE. ADDITIONAL INFORMATION MAY BE OBTAINED FROM MPEG LA, L.L.C. SEE [HTTP://WWW.MPEGLA.COM](http://www.mpegla.com)
- THIS PRODUCT IS LICENSED UNDER THE MPEG-4 VISUAL PATENT PORTFOLIO LICENSE FOR THE PERSONAL AND NON-COMMERCIAL USE OF A CONSUMER FOR (i) ENCODING VIDEO IN COMPLIANCE WITH THE MPEG-4 VISUAL STANDARD ("MPEG-4 VIDEO") AND/OR (ii) DECODING MPEG-4 VIDEO THAT WAS ENCODED BY A CONSUMER ENGAGED IN A PERSONAL AND NON-COMMERCIAL ACTIVITY AND/OR WAS OBTAINED FROM A VIDEO PROVIDER LICENSED BY MPEG LA TO PROVIDE MPEG-4 VIDEO. NO LICENSE IS GRANTED OR SHALL BE IMPLIED FOR ANY OTHER USE. ADDITIONAL INFORMATION INCLUDING THAT RELATING TO

PROMOTIONAL, INTERNAL AND COMMERCIAL USES AND LICENSING MAY BE OBTAINED FROM MPEG LA, LLC. SEE [HTTP://WWW.MPEGLA.COM](http://www.mpegla.com).

- THIS PRODUCT IS LICENSED UNDER THE VC-1 PATENT PORTFOLIO LICENSE FOR THE PERSONAL AND NON-COMMERCIAL USE OF A CONSUMER TO ( i ) ENCODE VIDEO IN COMPLIANCE WITH THE VC-1 STANDARD ("VC-1 VIDEO") AND/OR ( ii ) DECODE VC-1 VIDEO THAT WAS ENCODED BY A CONSUMER ENGAGED IN A PERSONAL AND NON-COMMERCIAL ACTIVITY AND/OR WAS OBTAINED FROM A VIDEO PROVIDER LICENSED TO PROVIDE VC-1 VIDEO. NO LICENSE IS GRANTED OR SHALL BE IMPLIED FOR ANY OTHER USE. ADDITIONAL INFORMATION MAY BE OBTAINED FROM MPEG LA, L.L.C. SEE [HTTP://WWW.MPEGLA.COM](http://www.mpegla.com)
- libFLAC  
Copyright (C) 2000-2009 Josh Coalson  
Copyright (C) 2011-2013 Xiph.Org Foundation  
Redistribution and use in source and binary forms, with or without modification, are permitted provided that the following conditions are met:
  - Redistributions of source code must retain the above copyright notice, this list of conditions and the following disclaimer.
  - Redistributions in binary form must reproduce the above copyright notice, this list of conditions and the following disclaimer in the documentation and/or other materials provided with the distribution.
  - Neither the name of the Xiph.org Foundation nor the names of its contributors may be used to endorse or promote products derived from this software without specific prior written permission. THIS SOFTWARE IS PROVIDED BY THE COPYRIGHT HOLDERS AND CONTRIBUTORS "AS IS" AND ANY EXPRESS OR IMPLIED WARRANTIES, INCLUDING, BUT NOT LIMITED TO, THE IMPLIED WARRANTIES OF MERCHANTABILITY AND FITNESS FOR A PARTICULAR PURPOSE ARE DISCLAIMED. IN NO EVENT SHALL THE FOUNDATION OR CONTRIBUTORS BE LIABLE FOR ANY DIRECT, INDIRECT, INCIDENTAL, SPECIAL, EXEMPLARY, OR CONSEQUENTIAL DAMAGES (INCLUDING, BUT NOT LIMITED TO, PROCUREMENT OF SUBSTITUTE GOODS OR SERVICES; LOSS OF USE, DATA, OR PROFITS; OR BUSINESS INTERRUPTION) HOWEVER CAUSED AND ON ANY THEORY OF LIABILITY, WHETHER IN CONTRACT, STRICT LIABILITY, OR TORT (INCLUDING NEGLIGENCE OR OTHERWISE) ARISING IN ANY WAY OUT OF THE USE OF THIS SOFTWARE, EVEN IF ADVISED OF THE POSSIBILITY OF SUCH DAMAGE.
- libvorbis  
Copyright (c) 2002-2008 Xiph.org Foundation  
Redistribution and use in source and binary forms, with or without modification, are permitted provided that the following conditions are met:
  - Redistributions of source code must retain the above copyright notice, this list of conditions and the following disclaimer.
  - Redistributions in binary form must reproduce the above copyright notice, this list of conditions and

the following disclaimer in the documentation and/or other materials provided with the distribution.

- Neither the name of the Xiph.org Foundation nor the names of its contributors may be used to endorse or promote products derived from this software without specific prior written permission. THIS SOFTWARE IS PROVIDED BY THE COPYRIGHT HOLDERS AND CONTRIBUTORS "AS IS" AND ANY EXPRESS OR IMPLIED WARRANTIES, INCLUDING, BUT NOT LIMITED TO, THE IMPLIED WARRANTIES OF MERCHANTABILITY AND FITNESS FOR A PARTICULAR PURPOSE ARE DISCLAIMED. IN NO EVENT SHALL THE FOUNDATION OR CONTRIBUTORS BE LIABLE FOR ANY DIRECT, INDIRECT, INCIDENTAL, SPECIAL, EXEMPLARY, OR CONSEQUENTIAL DAMAGES (INCLUDING, BUT NOT LIMITED TO, PROCUREMENT OF SUBSTITUTE GOODS OR SERVICES; LOSS OF USE, DATA, OR PROFITS; OR BUSINESS INTERRUPTION) HOWEVER CAUSED AND ON ANY THEORY OF LIABILITY, WHETHER IN CONTRACT, STRICT LIABILITY, OR TORT (INCLUDING NEGLIGENCE OR OTHERWISE) ARISING IN ANY WAY OUT OF THE USE OF THIS SOFTWARE, EVEN IF ADVISED OF THE POSSIBILITY OF SUCH DAMAGE.
- libogg  
Copyright (c) 2002, Xiph.org Foundation  
Redistribution and use in source and binary forms, with or without modification, are permitted provided that the following conditions are met:
  - Redistributions of source code must retain the above copyright notice, this list of conditions and the following disclaimer.
  - Redistributions in binary form must reproduce the above copyright notice, this list of conditions and the following disclaimer in the documentation and/or other materials provided with the distribution.
  - Neither the name of the Xiph.org Foundation nor the names of its contributors may be used to endorse or promote products derived from this software without specific prior written permission. THIS SOFTWARE IS PROVIDED BY THE COPYRIGHT HOLDERS AND CONTRIBUTORS "AS IS" AND ANY EXPRESS OR IMPLIED WARRANTIES, INCLUDING, BUT NOT LIMITED TO, THE IMPLIED WARRANTIES OF MERCHANTABILITY AND FITNESS FOR A PARTICULAR PURPOSE ARE DISCLAIMED. IN NO EVENT SHALL THE FOUNDATION OR CONTRIBUTORS BE LIABLE FOR ANY DIRECT, INDIRECT, INCIDENTAL, SPECIAL, EXEMPLARY, OR CONSEQUENTIAL DAMAGES (INCLUDING, BUT NOT LIMITED TO, PROCUREMENT OF SUBSTITUTE GOODS OR SERVICES; LOSS OF USE, DATA, OR PROFITS; OR BUSINESS INTERRUPTION) HOWEVER CAUSED AND ON ANY THEORY OF LIABILITY, WHETHER IN CONTRACT, STRICT LIABILITY, OR TORT (INCLUDING NEGLIGENCE OR OTHERWISE) ARISING IN ANY WAY OUT OF THE USE OF THIS SOFTWARE, EVEN IF ADVISED OF THE POSSIBILITY OF SUCH DAMAGE.

## Appendix

### ■ FCC WARNING

This equipment may generate or use radio frequency energy. Changes or modifications to this equipment may cause harmful interference unless the modifications are expressly approved in the instruction manual. The user could lose the authority to operate this equipment if an unauthorized change or modification is made.

#### NOTE

- This equipment has been tested and found to comply with the limits for a Class B digital device, pursuant to Part 15 of the FCC Rules. These limits are designed to provide reasonable protection against harmful interference in a residential installation.
- This equipment generates, used and can radiate radio frequency energy and, if not installed and used in accordance with the instructions may cause harmful interference to radio communications. However, there is no guarantee that interference will not occur in a particular installation. If this equipment does cause harmful interference to radio or television reception, which can be determined by turning the equipment off and on, the user is encouraged to try to correct the interference by one or more of the following measures:
  - Reorient or relocate the receiving antenna.
  - Increase the separation between the equipment and receiver.
  - Connect the equipment into an outlet on a circuit different from that to which the receiver is connected.
  - Consult the dealer or an experienced radio/TV technician for help.

### ▲ CAUTION

Use of controls or adjustments or performance of procedures other than those specified herein may result in hazardous radiation exposure.

In compliance with Federal Regulations, following are reproductions of labels on, or inside the product relating to laser product safety.

JVC KENWOOD Corporation  
2967-3, ISHIKAWA-MACHI,  
HACHIOJI-SHI, TOKYO, JAPAN

THIS PRODUCT COMPLIES WITH DHHS RULES  
21 CFR SUBCHAPTER J IN EFFECT AT DATE OF  
MANUFACTURE.

Location: Bottom plate (DNX995S)  
Top plate (DNX875S)

This transmitter must not be co-located or operated in conjunction with any other antenna or transmitter.

### ■ IC (Industry Canada) Notice

This device complies with Industry Canada's applicable licence-exempt RSSs.

Operation is subject to the following two conditions:

- (1) This device may not cause interference, and
- (2) this device must accept any interference, including interference that may cause undesired operation of the device.

### ▲ CAUTION

This equipment complies with FCC/IC radiation exposure limits set forth for an uncontrolled environment and meets the FCC radio frequency (RF) Exposure Guidelines and RSS-102 of the IC radio frequency (RF) Exposure rules. This equipment should be installed and operated keeping the radiator at least 20cm or more away from person's body.

### ■ CALIFORNIA, USA

This product contains a CR Coin Cell Lithium Battery which contains Perchlorate Material – special handling may apply.

See [www.dtsc.ca.gov/hazardouswaste/perchlorate](http://www.dtsc.ca.gov/hazardouswaste/perchlorate).

■ Información acerca de la eliminación de equipos eléctricos y electrónicos al final de la vida útil (aplicable a los países que hayan adoptado sistemas independientes de recogida de residuos)



Los productos con el símbolo de un contenedor con ruedas tachado no podrán ser desechados como residuos domésticos.

Los equipos eléctricos y electrónicos al final de la vida útil, deberán ser reciclados en instalaciones que puedan dar el tratamiento adecuado a estos productos y a sus subproductos residuales correspondientes. Póngase en contacto con su administración local para obtener información sobre el punto de recogida más cercano. Un tratamiento correcto del reciclaje y la eliminación de residuos ayuda a conservar los recursos y evita al mismo tiempo efectos perjudiciales en la salud y el medio ambiente.

■ Informação sobre a eliminação de pilhas

Este produto não deve ser eliminado como lixo doméstico geral. Devolva a pilha usada ao revendedor ou entidade autorizada para que a mesma seja devolvida ao fabricante ou importador.

A reciclagem e a eliminação de lixo de maneira apropriada ajudarão a conservar os recursos naturais ao mesmo tempo que prevenirão os efeitos prejudiciais à nossa saúde e ao meio ambiente.

■ Para cumplimiento de la IFT:

“La operación de este equipo esta sujeta a las siguientes dos condiciones:

- (1) es posible que este equipo o dispositivo no cause interferencia perjudicial y
  - (2) este equipo o dispositivo debe aceptar cualquier interferencia,
- incluyendo la que pueda causar su operación no deseada.”



android  
auto



Spotify



waze



YouTube



Bluetooth



WebLink™



pandora®

Made for



iPod



iPhone



Works with

Apple CarPlay



This HD Radio receiver enables:

HD2/HD3

Bookmark

Digital Sound

Program Info

Artist Experience

Emergency Alerts

# KENWOOD

# KENWOOD

**DNX995S**

**DNX875S**

**DNX695S**

**DNX575S**

---

GPS NAVIGATION SYSTEM

**INSTRUCTION MANUAL**

JVCKENWOOD Corporation

All rights reserved. Under the copyright laws, this manual may not be copied, in whole or in part, without the written consent of Garmin. Garmin reserves the right to change or improve its products and to make changes in the content of this manual without obligation to notify any person or organization of such changes or improvements. Go to [www.garmin.com](http://www.garmin.com) for current updates and supplemental information concerning the use of this product.

## Software License Agreement

BY USING THE DNX995S / DNX875S / DNX695S / DNX575S, YOU AGREE TO BE BOUND BY THE TERMS AND CONDITIONS OF THE FOLLOWING SOFTWARE LICENSE AGREEMENT. PLEASE READ THIS AGREEMENT CAREFULLY.

Garmin Ltd. and its subsidiaries ("Garmin") grant you a limited license to use the software embedded in this device (the "Software") in binary executable form in the normal operation of the product. Title, ownership rights, and intellectual property rights in and to the Software remain in Garmin and/or its third-party providers.

You acknowledge that the Software is the property of Garmin and/or its third-party providers and is protected under the United States of America copyright laws and international copyright treaties. You further acknowledge that the structure, organization, and code of the Software, for which source code is not provided, are valuable trade secrets of Garmin and/or its third-party providers and that the Software in source code form remains a valuable trade secret of Garmin and/or its third-party providers. You agree not to decompile, disassemble, modify, reverse assemble, reverse engineer, or reduce to human readable form the Software or any part thereof or create any derivative works based on the Software. You agree not to export or re-export the Software to any country in violation of the export control laws of the United States of America or the export control laws of any other applicable country.

## End User License Agreement

The infotainment system you have purchased for your vehicle may contain a navigation solution ("Navigation Solution"). The software embedded in the Navigation Solution (the "Software") is owned by the navigation solution provider or its subsidiaries (collectively, "Navigation Provider"). The map data that may be embedded in your Navigation Solution or downloaded separately (the "Map Data") is either owned by the Navigation Provider, or by HERE North America LLC and/or its affiliates ("HERE") or another third party and licensed to the Navigation Provider. The Navigation Provider also owns, or licenses from third party providers, information, traffic data, text, images, graphics, photographs, audio, video, images and other applications and data that may be embedded in the Navigation Solution, or downloaded separately ("Other Content"). The Map Data and Other Content are collectively the "Content". The Software and Content (collectively, the "Navigation Provider Products") are protected under copyright laws and international copyright treaties. The Navigation Provider Products are licensed, not sold. The structure, organization and code of the Software are valuable trade secrets of the Navigation Provider and/or its third-party providers. The Navigation Provider Products are each provided under this License Agreement and are subject to the following terms and conditions which are agreed to by End User ("you" or "your"), on the one hand, and the Navigation Provider and its licensors and affiliated companies of the Navigation

Provider and its licensors, on the other hand. The Navigation Provider's licensors, including the licensors, service providers, channel partners, suppliers and affiliated companies of the Navigation Provider and its licensors, are each a direct and intended third party beneficiary of this Agreement and may enforce their rights directly against you in the event of your breach of this Agreement.

**IMPORTANT: CAREFULLY READ THIS ENTIRE LICENSE AGREEMENT BEFORE PURCHASING OR USING YOUR NAVIGATION SOLUTION OR CONTENT. PURCHASING, INSTALLING, COPYING, OR OTHERWISE USING YOUR NAVIGATION SOLUTION OR CONTENT CONSTITUTES YOUR ACKNOWLEDGMENT THAT YOU HAVE READ THIS LICENSE AGREEMENT AND AGREE TO ITS TERMS AND CONDITIONS.**

## License Terms and Conditions

The Navigation Provider grants you a limited, non-exclusive license to use the applicable Navigation Provider Product in accordance with the terms of this Agreement. You agree to use the applicable Navigation Provider Product for solely personal use, or if applicable, for use in your business' internal operations, and not for service bureau, time-sharing, resale or other similar purposes. You agree not to otherwise reproduce, archive, copy, modify, decompile, disassemble, reverse engineer or create derivative works of any portion of the Navigation Solution, and may not transfer or distribute it in any form, for any purpose, except to the extent permitted by mandatory laws. The Navigation Provider also reserves the right to discontinue offering any Content supplied by any third party supplier if such supplier ceases to supply such content or the Navigation Provider's contract with such supplier terminates for any reason.

**Restrictions.** Except where you have been specifically licensed to do so by Navigation Provider, and without limiting the preceding paragraphs, you may not use the Navigation Provider Products with any products, systems, or applications installed or otherwise connected to or in communication with vehicles, and which are capable of dispatch, fleet management or similar applications where the Content is used by a central control center in dispatching a fleet of vehicles. In addition, you are prohibited from renting or leasing the Navigation Provider Products to any other person or third party.

You agree to be fully responsible for your own conduct and content while using the Software and for any consequences thereof. You agree to use the Software only for purposes that are legal, proper and in accordance with this Agreement and any applicable policies or guidelines. By way of example, and not as a limitation, you agree that when using the Software, You will not:

- upload, post, email or transmit or otherwise make available content that infringes any patent, trademark, copyright, trade secret or other proprietary right of any party, unless you are the owner of the rights or have the permission of the owner to post such Content;
- use the Software or other content for any illegal or unauthorized purpose; or
- transmit any viruses, worms, defects, Trojan horses, or any items of a destructive nature.

In the event that you are located outside of the United States, you agree to comply with any laws, rules or regulations in your locale or in the location of your web server regarding online conduct and acceptable content, including laws regulating the export of data to the United States or your country of residence.

**No Warranty.** The Navigation Provider Products are provided to you "as is," and you agree to use them at your own risk. The Navigation Provider and its licensors including the licensors, service providers, channel partners and suppliers, and affiliated companies of Navigation Provider and its licensors, make no guarantees, representations or warranties of any kind, express or implied, arising by law or otherwise, including but not limited to, content, quality, accuracy, completeness, effectiveness, reliability, merchantability, fitness for a particular purpose, usefulness, use or results to be obtained from the Navigation Provider Products, or that the Content or server will be uninterrupted or error-free. The Navigation Provider Products are intended to be used only as supplementary travel aids and must not be used for any purpose requiring precise measurement of direction, distance, location or topography. THE NAVIGATION PROVIDER MAKES NO WARRANTY AS TO THE ACCURACY OR COMPLETENESS OF THE MAP DATA OR OTHER CONTENT.

**Disclaimer of Warranty.** THE NAVIGATION PROVIDER AND ITS LICENSORS, INCLUDING THE LICENSORS, SERVICE PROVIDERS, CHANNEL PARTNERS, SUPPLIERS AND AFFILIATED COMPANIES OF THE NAVIGATION PROVIDER AND ITS LICENSORS, DISCLAIM ANY WARRANTIES, EXPRESS OR IMPLIED, OF QUALITY, PERFORMANCE, MERCHANTABILITY, FITNESS FOR A PARTICULAR PURPOSE OR NONINFRINGEMENT OF THE NAVIGATION PROVIDER PRODUCTS. NO ORAL OR WRITTEN ADVICE OR INFORMATION PROVIDED BY THE NAVIGATION PROVIDER OR ITS SUPPLIERS AND LICENSORS SHALL CREATE A WARRANTY, AND YOU ARE NOT ENTITLED TO RELY ON ANY SUCH ADVICE OR INFORMATION. THIS DISCLAIMER OF WARRANTIES IS AN ESSENTIAL CONDITION OF THIS AGREEMENT. Some States, Territories and Countries do not allow certain warranty exclusions, so to that extent the above exclusion may not apply to you.

**Disclaimer of Liability.** THE NAVIGATION PROVIDER AND ITS LICENSORS, INCLUDING THE LICENSORS, SERVICE PROVIDERS, CHANNEL PARTNERS, SUPPLIERS AND AFFILIATED COMPANIES OF THE NAVIGATION PROVIDER AND ITS LICENSORS, SHALL NOT BE LIABLE TO YOU: IN RESPECT OF ANY CLAIM, DEMAND OR ACTION, IRRESPECTIVE OF THE NATURE OF THE CAUSE OF THE CLAIM, DEMAND OR ACTION ALLEGING ANY LOSS, INJURY OR DAMAGES, DIRECT OR INDIRECT, WHICH MAY RESULT FROM THE USE OR POSSESSION OF THE NAVIGATION PROVIDER PRODUCTS; OR FOR ANY LOSS OF PROFIT, REVENUE, CONTRACTS OR SAVINGS, OR ANY OTHER DIRECT, INDIRECT, INCIDENTAL, SPECIAL OR CONSEQUENTIAL DAMAGES ARISING OUT OF YOUR USE OF OR INABILITY TO USE THE NAVIGATION PROVIDER PRODUCTS, ANY DEFECT IN THE CONTENT OR INFORMATION, OR THE BREACH OF THESE TERMS OR CONDITIONS, WHETHER IN AN ACTION IN CONTRACT OR TORT OR BASED ON A WARRANTY AND WHETHER RESULTING FROM THE USE, MISUSE, OR INABILITY TO USE THE NAVIGATION PROVIDER PRODUCTS OR FROM DEFECTS OR ERRORS IN THE APPLICATION, EVEN IF GARMIN OR ITS LICENSORS HAVE BEEN ADVISED OF THE POSSIBILITY OF SUCH DAMAGES. THE NAVIGATION PROVIDER'S AND ITS LICENSORS' TOTAL AGGREGATE LIABILITY WITH RESPECT TO ITS OBLIGATIONS UNDER THIS LICENSE AGREEMENT OR OTHERWISE WITH RESPECT TO THE APPLICATION OR THE CONTENT SHALL

NOT EXCEED \$1.00. Some States, Territories and Countries do not allow certain liability exclusions or damages limitations, so to that extent the above may not apply to you.

ANY CONTENT OR MATERIAL DOWNLOADED OR UPLOADED OR OTHERWISE OBTAINED THROUGH THE SOFTWARE IS DONE AT YOUR OWN DISCRETION AND RISK. YOU WILL BE SOLELY RESPONSIBLE FOR ANY DAMAGE TO YOUR ELECTRONIC COMMUNICATION DEVICE OR ANY LOSS OF DATA THAT MAY RESULT FROM THE DOWNLOAD OR UPLOAD OF ANY SUCH CONTENT OR MATERIAL OR THE USE OF THE SOFTWARE.

**Predictive Routing.** Your Navigation Solution may have a "predictive routing" feature called myTrends that identifies your driving routines. If it does have this feature, when your device predicts a route, it will display your estimated time to destination and relevant traffic information regarding the predicted route. Information related to your driving routines would be accessible to any other person who uses your device. If you do not want your device to predict your routes or display information related to predicted routes, you may turn off myTrends by accessing your navigation system's Settings menu.

**Disclaimer of Endorsement; Change of Content Providers.**

Reference to any products, services, processes, hypertext links to third parties or other Content by trade name, trademark, manufacturer, supplier or otherwise does not necessarily constitute or imply its endorsement, sponsorship or recommendation by the Navigation Provider or its licensors. Product and service information are the sole responsibility of each individual vendor. The HERE name and logo, the HERE and HERE ON BOARD trademarks and logos, and other trademarks and trade names owned by HERE North America LLC may not be used in any commercial manner without the prior written consent of HERE. Content providers may be changed by the Navigation Provider during the term of this Agreement, and your experience with the Content provided by a new provider may not duplicate your experience with the previous Content supplier.

**Export Control.** You agree not to export from anywhere any part of the Content or any direct product thereof except in compliance with and with all licenses and approvals required under, applicable export laws, rules and regulations. You understand and acknowledge that this product, application or software may not be transferred directly or indirectly to Crimea, Crimean individuals, or Crimean entities.

**Legal Compliance.** You represent and warrant that (i) you are not located in a country that is subject to a U.S. Government embargo, or has been designated by the U.S. Government as a "terrorist supporting" country, and (ii) you are not listed on any U.S. Government list of prohibited or restricted parties.

**Indemnity.** You agree to indemnify, defend and hold the Navigation provider and its licensors, including the respective licensors, service providers, channel partners, suppliers, assignees, subsidiaries, affiliated companies, and the respective officers, directors, employees, shareholders, agents and representatives of the Navigation Provider and its licensors, free and harmless from and against any liability, loss, injury (including injuries resulting in death), demand, action, cost, expense, or claim of any kind or character, including but not limited to attorney's fees, arising out of or in connection with any use or possession by you of the Navigation Provider Products.

**Map Data.** Use of the Map Data is subject to certain restrictions and/or requirements imposed by third party suppliers and/or

governmental or regulatory authorities, and in the case of HERE Data, as further set forth at [http://corporate.navteq.com/supplier\\_terms.html](http://corporate.navteq.com/supplier_terms.html).

**Term.** This Agreement is effective until such time as (i) if applicable, your subscription term is either terminated (by you or by the Navigation Provider) or expires, or (ii) Navigation Provider terminates this Agreement for any reason, including, but not limited to, if the Navigation Provider finds that you have violated any of the terms of this Agreement. In addition, this Agreement shall terminate immediately upon the termination of an agreement between the Navigation Provider and any third party from whom the Navigation Provider (a) obtains services or distribution necessary to support the Navigation Provider Products, or (b) licenses Content. You agree, upon termination, to destroy all copies of the Content. The Disclaimers of Warranty and Liability set out above shall continue in force even after any termination.

**Entire Agreement.** These terms and conditions constitute the entire agreement between the Navigation Provider and its licensors, including the licensors, service providers, channel partners, suppliers and affiliated companies of the Navigation Provider and its licensors, and you pertaining to the subject matter hereof, and supersedes in their entirety any and all written or oral agreements previously existing between us with respect to such subject matter.

#### **Governing Law.**

(a) For European Union HERE Data

The above terms and conditions shall be governed by the laws of the Netherlands, without giving effect to (i) its conflict of laws provisions, or (ii) the United Nations Convention for Contracts for the International Sale of Goods, which is explicitly excluded. You agree to submit to the jurisdiction of the Netherlands for any and all disputes, claims and actions arising from or in connection with the HERE Data provided to you hereunder.

(b) For North American HERE Data and other non-European Union HERE Data

The above terms and conditions shall be governed by the laws of Illinois, without giving effect to (i) its conflict of laws provisions, or (ii) the United Nations Convention for Contracts for the International Sale of Goods, which is explicitly excluded. You agree to submit to the jurisdiction of Illinois for any and all disputes, claims and actions arising from or in connection with the HERE Data provided to you hereunder.

(c) For disputes, claims and actions not related to the HERE Data

The above terms and conditions shall be governed by the laws of Kansas, without giving effect to (i) its conflict of laws provisions, or (ii) the United Nations Convention for Contracts for the International Sale of Goods, which is explicitly excluded. You agree to submit to the jurisdiction of Kansas for any and all disputes, claims and actions arising from or in connection with the Application or Content. Any translation of this Agreement from English is provided as a convenience only. If this Agreement is translated into a language other than English and there is a conflict of terms between the English version and the other language version, the English version will control.

#### **Map Data Government End Users.**

If End User is an agency, department, or other entity of the United States Government, or funded in whole or in part by the U.S. Government, then use, duplication, reproduction, release, modification, disclosure or transfer of the Map Data is subject to restrictions as set forth in DFARS 252.227-7014(a)(1) (JUN

1995) (DOD commercial computer software definition), DFARS 27.7202-1 (DOD policy on commercial computer software), FAR 52.227-19 (JUN 1987) (commercial computer software clause for civilian agencies), DFARS 252.227-7015 (NOV 1995) (DOD technical data - commercial items clause); FAR 52.227-14 Alternates I, II, and III (JUN 1987) (civilian agency technical data and noncommercial computer software clause); and/or FAR 12.211 and FAR 12.212 (commercial item acquisitions), as applicable. In case of conflict between any of the FAR and DFARS provisions listed herein and this License Agreement, the construction that provides greater limitations on the Government's rights shall control. The contractor/manufacturer is HERE North America LLC, 425 West Randolph Street, Chicago, Illinois 60606 USA.

HERE is a trademark in the U.S. and other countries. All other company names and trademarks mentioned or referenced in this documentation are the properties of their respective owners. All rights reserved.

#### **Trademark Notices**

Garmin® and the Garmin logo are trademarks of Garmin Ltd. or its subsidiaries, registered in the USA and other countries. ecoRoute™, myTrends™, and trafficTrends™ are trademarks of Garmin Ltd. or its subsidiaries. These trademarks may not be used without the express permission of Garmin.

The Bluetooth® word mark and logos are owned by the Bluetooth SIG, Inc., and any use of such name by Garmin is under license. All other company names and trademarks mentioned or referenced in this documentation are the properties of their respective owners. All rights reserved.

# Table of Contents

<b>Getting Started</b> .....	<b>1</b>
Navigation System.....	1
Status Bar Icons.....	1
Using the On-Screen Buttons.....	1
Removing a Shortcut.....	1
Adding a Shortcut.....	1
Using Multi-touch Controls.....	1
Updating the Software.....	1
Updating Map Data.....	1
<b>Finding Locations</b> .....	<b>1</b>
About Locations.....	1
Finding a Location by Category.....	2
Finding a Location Using the Search Bar.....	2
Changing the Search Area.....	2
Search Tools.....	2
Finding an Address.....	2
Finding an Intersection.....	2
Finding a City.....	3
Finding a Location Using Coordinates.....	3
Starting a Route by Using the Map.....	3
Finding a Location Using Quick Search.....	3
Saving a Home Location.....	3
Going Home.....	3
Editing Your Home Location Information.....	3
Finding Recently Found Places.....	3
Clearing the List of Recently Found Places.....	3
Finding Parking.....	4
Setting a Simulated Location.....	4
Saving Locations.....	4
Saving a Location.....	4
Saving Your Current Location.....	4
Starting a Route to a Saved Location.....	4
Editing a Saved Location.....	4
Assigning Categories to a Saved Location.....	4
<b>Navigation</b> .....	<b>4</b>
Starting a Route.....	4
Previewing Multiple Routes.....	4
Your Route on the Map.....	5
Using the Map.....	5
Adding a Point to a Route.....	5

Taking a Detour.....	5
Stopping the Route.....	5
Using Suggested Routes.....	5
About Exit Services.....	5
Finding Exit Services.....	5
Navigating to an Exit.....	5
Avoiding Road Features.....	6
About Custom Avoidances.....	6
Avoiding an Area.....	6
Avoiding a Road.....	6
Disabling a Custom Avoidance.....	6
Deleting Custom Avoidances.....	6
Enabling Advanced Detours.....	6
Taking a Detour.....	6
Custom Points of Interest.....	6
Installing POI Loader Software.....	6
Installing Custom Points of Interest....	6
Using the POI Loader Help Files.....	7
Finding Extras.....	7
<b>Map Pages</b> .....	<b>7</b>
Customizing the Map.....	7
Customizing the Map Layers.....	7
Viewing the Trip Log.....	7
Changing the Map Data Field.....	7
Customizing Map Buttons.....	7
Changing the Map Perspective.....	7
Viewing Route Activity.....	7
Viewing a List of Turns.....	7
Viewing the Next Turn.....	8
Viewing Traffic Alerts.....	8
Viewing Junctions.....	8
Viewing the Trip Information Page.....	8
Getting Directions to Your Current Location.....	8
Viewing Current Location Information....	8
Finding Nearby Services.....	8
<b>Using the Apps</b> .....	<b>8</b>
Searching Help Topics.....	8
About ecoRoute.....	8
Setting Up the Vehicle.....	8
Calibrating the Fuel Economy.....	8
Changing the Fuel Price.....	9
About ecoChallenge.....	9
Viewing Fuel Economy Information....	9
Mileage Reports.....	9
Resetting ecoRoute Information.....	9
Planning a Trip.....	9
Scheduling a Trip.....	10
Navigating to a Saved Trip.....	10
Editing a Saved Trip.....	10

- Saving Trip Logs ..... 10
- Viewing Previous Routes and Destinations ..... 10
- Viewing the Weather Forecast ..... 10
  - Viewing Weather Near a Different City ..... 10
- Viewing Road Weather ..... 10
- Finding Fuel Stations and Prices ..... 11
- Dynamic Parking ..... 11
- About Traffic ..... 11**
  - Traffic Data Using INRIX Traffic Service ..... 11
  - About the Traffic Icon ..... 11
  - Traffic on Your Route ..... 11
    - Viewing Traffic on Your Route ..... 11
    - Manually Avoiding Traffic on Your Route ..... 11
    - Taking an Alternate Route ..... 11
    - Viewing Traffic on the Map ..... 11
  - Traffic in Your Area ..... 12
    - Searching for Traffic Delays ..... 12
    - Viewing a Traffic Incident on the Map ..... 12
- Understanding Traffic Data ..... 12
- Customizing the Device ..... 12**
  - Map and Vehicle Settings ..... 12
    - Enabling Maps ..... 12
  - Navigation Settings ..... 12
    - Changing the Route Calculation Mode ..... 12
  - Display Settings ..... 13
    - Changing the Color Mode ..... 13
  - Traffic Settings ..... 13
    - trafficTrends ..... 13
    - Disabling trafficTrends ..... 13
  - Units and Time Settings ..... 13
  - Language and Keyboard Settings ..... 13
  - Device and Privacy Settings ..... 13
  - Proximity Alerts Settings ..... 13
  - Restoring Settings ..... 13

# Getting Started

## ⚠ WARNING

See the *Safety Precautions and Important Information* in the KENWOOD system instruction manual for product warnings and other important information.

**NOTE:** The screenshots shown in this manual may not exactly match the screens on your navigation system. The images used in this manual are intended for reference only.

## Navigation System



For complete audio system information, see the KENWOOD system instruction manual.









① Opens the navigation system when selected.

## Status Bar Icons

The status bar is at the top of the main menu. The status bar icons display information about features on the device. You can select some icons to change settings or view additional information.

	GPS signal status
	Current time
	INRIX Traffic Service status

## Using the On-Screen Buttons

- Select  to return to the previous menu screen.
- Hold  to quickly return to the main menu.
- Select  or  to see more choices.
- Hold  or  to scroll faster.
- Select  to see a menu of options for the current screen.

## Removing a Shortcut

- 1 Select **Where To?** >  > **Remove Shortcut(s)**.

- 2 Select a shortcut to remove.
- 3 Select the shortcut again to confirm.
- 4 Select **Save**.

## Adding a Shortcut

You can add shortcuts to the **Where To?** menu. A shortcut can point to a location, a category, or a search tool.

The **Where To?** menu can contain up to 36 shortcut icons.

- 1 Select **Where To?** > **Add Shortcut**.
- 2 Select an item.

## Using Multi-touch Controls

You can use multi-touch controls to change the map view while using the navigation map.

**NOTE:** This feature is not available on all models.

- Pinch two fingers together on the screen to zoom out.
- Spread two fingers on the screen to zoom in.

## Updating the Software

Before you can update the navigation system software, you must have an SD card and a USB mass storage device, and an internet connection.

- 1 Go to [www.garmin.com/kenwood](http://www.garmin.com/kenwood).
- 2 From the **Product Updates** section, select **Update**.
- 3 Follow the on-screen instructions.

## Updating Map Data

You can purchase updated map data from Garmin®.

- 1 Go to [www.garmin.com/kenwood](http://www.garmin.com/kenwood).
- 2 From the **Map Updates** section, select **Update**.
- 3 Follow the on-screen instructions.

## Finding Locations

### About Locations

The detailed maps loaded in your device contain locations, such as restaurants,

hotels, and auto services. You can use categories to browse for nearby businesses and attractions.

## Finding a Location by Category

- 1 Select **Where To?**.
- 2 Select a category, or select **Categories**.
- 3 If necessary, select a subcategory.
- 4 Select a location.

### Searching Within a Category

To narrow your search results, you can search within some categories.

- 1 Select **Where To?**.
- 2 Select a category, or select **Categories**.
- 3 If necessary, select a subcategory.
- 4 If necessary, enter all or part of the name in the search bar.

### Calling a Location

Before you can use this feature, you must connect your compatible mobile phone using Bluetooth® wireless technology.

- 1 Select **Where To? > Categories**.
- 2 Select a location.
- 3 Select **i**.
- 4 Select **Call**.

## Finding a Location Using the Search Bar

You can use the search bar to search for locations by entering a category, brand name, address, or city name.

- 1 Select **Where To?**.
- 2 Select **Enter Search** in the search bar.
- 3 Enter all or part of the search term.  
Suggested search terms appear below the search bar.
- 4 Select an option:
  - To search for a type of business, enter a category name (for example, "movie theaters").
  - To search for a business name, enter all or part of the name.
  - To search for an address near you, enter the house number and street name.

- To search for an address in another city, enter the house number, street name, city, and state.
- To search for a city, enter the city and state.
- To search for coordinates, enter latitude and longitude coordinates.

### 5 Select an option:

- To search using a suggested search term, select the term.
- To search using the text you entered, select **Q**.

### 6 If necessary, select a location.

## Changing the Search Area

- 1 From the main menu, select **Where To?**.
- 2 Select **Searching near:**.
- 3 Select an option.

## Search Tools

Search tools allow you to search for specific types of locations by responding to on-screen prompts.

### Finding an Address

**NOTE:** The order of the steps may change depending on the map data loaded on your device.

- 1 Select **Where To? > Address**.
- 2 If necessary, select **State or Country** to change the search area.
- 3 Select an option:
  - To narrow your search to a city in the search area, select **Spell City**.
  - To narrow your search to a postal code in the search area, select **Enter Postal Code**.
  - To search for an address in all cities and postal codes in the search area, select **Search All**.
- 4 Follow the on-screen instructions to enter address information.
- 5 Select the address.

### Finding an Intersection

You can search for an intersection or junction between two streets, highways, or other roads.

- 1 Select **Where To?** > **Categories** > **Intersections**.
- 2 Follow the on-screen instructions to enter street information.
- 3 Select the intersection.

## Finding a City

- 1 Select **Where To?** > **Categories** > **Cities**.
- 2 Select an option:
  - Select a city from the list of nearby cities.
  - To search near another location, select **Searching near:** ([Changing the Search Area](#)).
  - To search for a city by name, select **Enter Search**, enter a city name, and select **Q**.

## Finding a Location Using Coordinates

You can find a location using latitude and longitude coordinates.

- 1 Select **Where To?** > **Categories** > **Coordinates**.
- 2 If necessary, select **≡** > **Format**, select the correct coordinate format for the type of map you are using, and select **Save**.
- 3 Select the latitude coordinate.
- 4 Enter the new coordinate, and select **Done**.
- 5 Select the longitude coordinate.
- 6 Enter the new coordinate, and select **Done**.
- 7 Select **View on Map**.

## Starting a Route by Using the Map

You can start route by selecting a location from the map.

- 1 Select **View Map**.
- 2 Drag and zoom the map to display the area to search.
- 3 If necessary, select **Q** to filter the displayed points of interest by category. Location markers (📍 or a blue dot) appear on the map.
- 4 Select an option:
  - Select a location marker.

- Select a point, such as a street, intersection, or address location.

- 5 Select **Go!**.

## Finding a Location Using Quick Search

After you have performed a search for a point of interest, certain categories may display a Quick Search list that displays the last four destinations you selected.

- 1 Select **Where To?**.
- 2 Select a category, or select **Categories**.
- 3 If applicable, select a destination from the Quick Search list.
- 4 If necessary, select the appropriate destination.

## Saving a Home Location

You can set your home location for the location you return to most often.

- 1 Select **Where To?** > **≡** > **Set Home Location**.
- 2 Select **Enter My Address, Use Current Location**, or **Recently Found**.

The location is saved as "Home" in the Saved menu.

## Going Home

Select **Where To?** > **Go Home**.

## Editing Your Home Location Information

- 1 Select **Where To?** > **Saved** > **Home**.
- 2 Select **i**.
- 3 Select **≡** > **Edit**.
- 4 Enter your changes.
- 5 Select **Done**.

## Finding Recently Found Places

Your device stores the last 50 locations you have found.

- 1 Select **Where To?** > **Recent**.
- 2 Select a location.

## Clearing the List of Recently Found Places

Select **Where To?** > **Recent** > **≡** > **Clear** > **Yes**.

## Finding Parking

- 1 Select **Where To?** > **Categories** > **Parking**.
- 2 Select a parking location.

## Setting a Simulated Location

If you are indoors or not receiving satellite signals, you can use the GPS to set a simulated location.

- 1 Select **Settings** > **Navigation** > **GPS Simulator**.
- 2 From the main menu, select **View Map**.
- 3 Tap the map twice to select an area.  
The address of the location appears at the bottom of the screen.
- 4 Select the location description.
- 5 Select **Set Location**.

## Saving Locations

### Saving a Location

- 1 Search for a location ([Finding a Location by Category](#)).
- 2 From the search results, select a location.
- 3 Select **i**.
- 4 Select **≡** > **Save**.

### Saving Your Current Location

- 1 From the map, select the vehicle icon.
- 2 Select **Save**.
- 3 Enter a name, and select **Done**.
- 4 Select **OK**.

### Starting a Route to a Saved Location

- 1 Select **Where To?** > **Saved**.
- 2 If necessary, select a category, or select **All Saved Places**.
- 3 Select a location.
- 4 Select **Go!**.

### Editing a Saved Location

- 1 Select **Where To?** > **Saved**.
- 2 If necessary, select a category.
- 3 Select a location.
- 4 Select **i**.
- 5 Select **≡** > **Edit**.

- 6 Select an option:
  - Select **Name**.
  - Select **Phone Number**.
  - Select **Categories** to assign categories to the saved location.
  - Select **Change Map Symbol** to change the symbol used to mark the saved location on a map.
- 7 Edit the information.
- 8 Select **Done**.

### Assigning Categories to a Saved Location

You can add custom categories to organize your saved locations.

**NOTE:** Categories appear in the saved locations menu after you have saved at least 12 locations.

- 1 Select **Where To?** > **Saved**.
- 2 Select a location.
- 3 Select **i**.
- 4 Select **≡** > **Edit** > **Categories**.
- 5 Enter one or more category names, separated by commas.
- 6 If necessary, select a suggested category.
- 7 Select **Done**.

## Navigation

### Starting a Route

- 1 Search for a location ([About Locations](#)).
- 2 Select a location.
- 3 Select **Go!**.
- 4 If necessary, select a route.

### Previewing Multiple Routes

- 1 Search for a location ([Finding a Location by Category](#)).
- 2 From the search results, select a location.
- 3 Select **Routes**.
- 4 Select a route.
- 5 Select **Go!**.

## Your Route on the Map









### NOTICE

The speed limit feature is for information only and does not replace your responsibility to abide by all posted speed limit signs and to use safe driving judgment at all times. Garmin and JVC KENWOOD will not be responsible for any traffic fines or citations you receive for failing to follow all applicable traffic laws and signs.

The route is marked with a magenta line. A checkered flag marks your destination.

As you travel, the device guides you to the destination with voice prompts, arrows on the map, and directions at the top of the map. If you depart from the original route, the device recalculates the route and provides new directions.

### Using the Map

- 1 From the main menu, select **View Map**.
- 2 If the zoom controls are hidden, select the map to display the zoom controls.
- 3 Select the map.
- 4 Select an option:
  - To zoom in or out, select  or .
  - To rotate the map view, select .
  - To switch between North Up and 3-D views, select .
  - To add or remove map layers, select .
  - To view specific categories, select .
  - To center the map on your current location, select .
  - To view shortcuts for map and navigation features, select .

### Adding a Point to a Route

Before you can add a point, you must be navigating a route.

- 1 From the map, select  > **Where To?**
- 2 Search for a location.
- 3 Select a location.
- 4 Select **Go!**.
- 5 Select **Add to Active Route**.

### Taking a Detour

While navigating a route, you can use detours to avoid obstacles ahead of you, such as construction zones.

While navigating, select  > **Detour**.

### Stopping the Route

From the map, select  > **Stop**.

### Using Suggested Routes

Before you can use this feature, you must save at least one location and enable the travel history feature ([Device and Privacy Settings](#)).





Using the myTrends™ feature, your device predicts your destination based on your travel history, the day of the week, and the time of day. After you have driven to a saved location several times, the location may appear in the navigation bar on the map, along with the estimated time of travel, and traffic information.

Select the navigation bar to view a suggested route to the location.

### About Exit Services

**NOTE:** You must be on a major highway or road to view exit services.



While navigating a route, you can find businesses and services near upcoming exits. Services are listed by category.

	Gas
	Food
	Lodging
	Restrooms

### Finding Exit Services

- 1 From the map, select  > **Exit Services**.
- 2 Use the arrows to select an upcoming exit.
- 3 Select an exit service tab.
- 4 Select a point of interest.

### Navigating to an Exit

- 1 From the map, select  > **Exit Services** > .
- 2 Select **Go!**.

## Avoiding Road Features

- 1 Select **Settings > Navigation > Avoidances**.
- 2 Select the road features to avoid on your routes, and select **Save**.

## About Custom Avoidances

Custom avoidances allow you to avoid specific areas and sections of road. You can enable and disable custom avoidances as needed.

### Avoiding an Area

- 1 Select **Settings > Navigation > Custom Avoidances**.
- 2 If necessary, select **Add Avoidance**.
- 3 Select **Add Avoid Area**.
- 4 Select the upper-left corner of the area to avoid, and select **Next**.
- 5 Select the lower-right corner of the area to avoid, and select **Next**.  
The selected area is shaded on the map.
- 6 Select **Done**.

### Avoiding a Road

- 1 Select **Settings > Navigation > Custom Avoidances**.
- 2 Select **Add Avoid Road**.
- 3 Select the starting point of the section of road to avoid, and select **Next**.
- 4 Select the ending point of the road section, and select **Next**.
- 5 Select **Done**.

### Disabling a Custom Avoidance

You can disable a custom avoidance without deleting it.

- 1 Select **Settings > Navigation > Custom Avoidances**.
- 2 Select an avoidance.
- 3 Select **≡ > Disable**.

### Deleting Custom Avoidances

- 1 Select **Settings > Navigation > Custom Avoidances**.
- 2 Select an option:
  - To delete all custom avoidances, select **✕**.

- To delete one custom avoidance, select the avoidance, and select **≡ > Delete**.

## Enabling Advanced Detours

Select **Settings > Navigation > Advanced Detours**.

### Taking a Detour

Before you can take a detour, you must be navigating a route.

You can take a detour for a specified distance along your route or detour around specific roads. This is useful if you encounter construction zones, closed roads, or poor road conditions.

- 1 From the map, select **≡ > Detour**.
- 2 Select an option.
  - To detour your route for a specific distance, select a distance.
  - To detour around a specific road on the route, select **Detour by Road(s) on Route**, and select a road around which to detour.

## Custom Points of Interest

Custom POIs are customized points on the map. They can contain alerts that let you know if you are near a designated point or if you are traveling faster than a specified speed.

### Installing POI Loader Software

You can create or download custom POI lists on your computer and install them on your device using POI Loader software. You must use a USB mass storage device to load POIs.

- 1 Go to [www.garmin.com/extras](http://www.garmin.com/extras).
- 2 Click **Services & Utilities > POI Loader**.
- 3 Install the POI Loader onto your computer.

### Installing Custom Points of Interest

Before you can install custom points of interest, you must prepare POI lists for installation using the POI Loader application.

- 1 Connect a USB mass storage device to your computer.
- 2 On the USB mass storage device, create a new folder named Garmin.

- 3 Copy the custom POI files to the Garmin folder on the USB mass storage device.
- 4 Connect the USB mass storage device to your KENWOOD system.
- 5 On the KENWOOD system screen, select **Yes**.
- 6 Select **Custom POIs**.
- 7 Select **Install**.

The KENWOOD system imports the custom points of interest into the system storage.

## Using the POI Loader Help Files

For more information on the POI loader, refer to the Help file.

With the POI loader open, click **Help**.

## Finding Extras

- 1 Select **Where To? > Categories > Custom POIs**.
- 2 Select a category.

# Map Pages

## Customizing the Map

### Customizing the Map Layers

You can customize which data appear on the map, such as icons for points of interest and road conditions.

- 1 From the map, select .
- 2 Select **Map Layers**.
- 3 Select which layers you want to include on the map, and select **Save**.

### Viewing the Trip Log

Your device keeps a trip log, which is a record of the path you have traveled.

- 1 Select **Settings > Map & Vehicle > Map Layers**.
- 2 Select the **Trip Log** check box.
- 3 Select **Save**.

### Changing the Map Data Field

- 1 From the map, select the data field in the lower left-hand corner.
- 2 Select a type of data to display.
- 3 Select **Save**.

## Customizing Map Buttons

You can include up to three icons on the right side of the main map.

- 1 Select **Settings > Map & Vehicle > Map Buttons**.
- 2 Select an icon, and select **OK**.
- 3 Select .
- 4 Select a different icon.
- 5 Select **Save**.

### Removing Buttons from the Map

You can remove all buttons from the right side of the map.

- 1 Select **Settings > Map & Vehicle > Map Buttons**.
- 2 Select an icon, and select **OK**.
- 3 Select **Save**.

## Changing the Map Perspective

- 1 Select **Settings > Map & Vehicle > Driving Map View**.
- 2 Select an option:
  - Select **Track Up** to display the map in two dimensions (2-D), with your direction of travel at the top.
  - Select **North Up** to display the map in 2-D with north at the top.
  - Select **3-D** to display the map in three dimensions.
- 3 Select **Save**.

## Viewing Route Activity

### Viewing a List of Turns

While navigating a route, you can view all of the turns and maneuvers for your entire route and the distance between turns.

- 1 While navigating a route, select the text bar on the top of the map.
- 2 Select a turn.

The details for the turn appear. If available, an image of the junction appears for junctions on major roadways.

### Viewing the Entire Route on the Map

- 1 While navigating a route, select the navigation bar at the top of the map.
- 2 Select  > **Map**.

## Viewing the Next Turn

While navigating a route, a preview of the next turn, lane change, or other maneuver appears in the upper-left corner of the map.

The preview includes the distance to the turn or maneuver and the lane in which you should be traveling, if available.

From the map, select  to view the next turn on the map.

## Viewing Traffic Alerts

While navigating a route, a traffic alert may appear in the navigation bar.

Select the alert to view more information.

## Viewing Junctions

While navigating a route, you can view the junctions on major roadways. When you approach a junction in a route, the image of that junction appears briefly, if available.

**NOTE:** This feature is not available on all models.

From the map, select  to view the junction, if available.

## Viewing the Trip Information Page

The trip information page displays your speed and provides statistics about your trip.

**NOTE:** If you make frequent stops, leave the device turned on, so it can accurately measure elapsed time during the trip.

From the map, select **Speed**.

### Resetting Trip Information

- 1 From the map, select **Speed**.
- 2 Select  > **Reset All**.
- 3 Select an option:
  - When not navigating a route, select **Select All** to reset every data field except the speedometer, on the first page.
  - Select **Reset Trip Data** to reset the information on the trip computer.
  - Select **Reset Trip B** to reset the odometer.
  - Select **Reset Max. Speed** to reset the maximum speed.
- 4 Select **Reset**.

## Getting Directions to Your Current Location

If you need to tell another person how to get to your current location, your device can give you a list of directions.

- 1 From the map, select the vehicle.
- 2 Select  > **Directions to Me**.

## Viewing Current Location Information

You can use the Where Am I? page to view information about your current location. This feature is helpful if you need to tell emergency personnel your location.

From the map, select  > **Where Am I?**

## Finding Nearby Services

You can use the Where Am I? page to find nearby services, such as hospitals or police stations.

- 1 From the map, select  > **Where Am I?**
- 2 Select a category.

# Using the Apps

## Searching Help Topics

Select **Apps** > **Help** > **Q**.

## About ecoRoute

The ecoRoute™ feature calculates the fuel economy and the fuel price of navigating to a destination, and offers tools for improving fuel efficiency.

The data provided by the ecoRoute feature is an estimate only.

To receive more-accurate fuel reports for your specific vehicle and driving habits, calibrate the fuel economy ([Calibrating the Fuel Economy](#)).

## Setting Up the Vehicle

The first time you use the ecoRoute features, you must enter vehicle information.

- 1 Select **Apps** > **ecoRoute™**.
- 2 Follow the on-screen instructions.

## Calibrating the Fuel Economy

You can calibrate the fuel economy to receive more-accurate fuel reports for your

specific vehicle and driving habits. You should calibrate when you fill up your fuel tank.

- 1 Select **Apps** > **ecoRoute™** > **At the Pump**.
- 2 Enter the current fuel price.
- 3 Enter the amount of fuel the vehicle has used since the last time the fuel tank was filled.
- 4 Enter the distance you have traveled since the last time the fuel tank was filled.
- 5 Select **Next**.  
The device calculates the average vehicle fuel economy.
- 6 Select **Save**.

### Changing the Fuel Price

- 1 Select **Apps** > **ecoRoute™** > **At the Pump**.
- 2 Enter the current price of fuel, and select **Next**.
- 3 Select **Yes**.

### About ecoChallenge

ecoChallenge helps you maximize the vehicle fuel economy by scoring your driving habits. The higher your ecoChallenge scores, the more fuel you have saved. ecoChallenge collects data and calculates a score whenever your vehicle is moving.

#### Viewing ecoChallenge Scores

Select **Apps** > **ecoRoute™** > **ecoChallenge**.

#### About the ecoChallenge Score

The leaf color on the ecoChallenge icon changes depending on your performance in the challenge.

**Overall:** Displays an average of the speed, acceleration, and braking score.

**Speed:** Displays your score for driving your vehicle at the optimal speed for conserving fuel.

**Acceleration:** Displays your score for smooth and gradual acceleration. You lose points for rapid acceleration.

**Braking:** Displays your score for smooth and gradual braking. You lose points for hard braking.

### Resetting the ecoChallenge Scores

- 1 Select **Apps** > **ecoRoute™** > **ecoChallenge**.
- 2 Select  > **Reset**.
- 3 Select **Yes**.

### Viewing Fuel Economy Information

- 1 Select **Apps** > **ecoRoute™** > **Fuel Economy**.
- 2 Select a section of the graph to zoom in.

### Mileage Reports

Mileage reports provide the distance, the time, the average fuel economy, and the fuel cost of navigating to a destination.

A mileage report is created for every route that you drive. If you stop a route on your device, a mileage report is created for the distance you traveled.

#### Exporting a Mileage Report

- 1 Connect a USB mass storage device to your KENWOOD unit.
- 2 Select **Apps** > **ecoRoute™** > **Mileage Report**.
- 3 Select **Export** to export and save a report to the USB mass storage device.

### Resetting ecoRoute Information

- 1 Select **Apps** > **ecoRoute™** > **Vehicle Profile**.
- 2 Select **Reset**.
- 3 Select **Yes**.

### Planning a Trip

You can use the trip planner to create and save a trip with multiple destinations.

- 1 Select **Apps** > **Trip Planner**.
- 2 Select **New Trip**.
- 3 Select **Select Start Location**.
- 4 Search for a location ([Finding a Location by Category](#)).
- 5 Select **Select**.
- 6 To add additional locations, select .
- 7 Search for a location.
- 8 Select **Select**.
- 9 Select **Next**.
- 10 Enter a name, and select **Done**.

## Scheduling a Trip

You can add scheduling information to each location in your trip, including the desired arrival time and layover duration at each location. This can help you plan your departure to reach locations in your trip on time.

- 1 Select **Apps > Trip Planner**.
- 2 Select a trip.
- 3 Select a location.
- 4 Select **Departure Time** or **Arrival Time**.
- 5 Select a date and time, and select **Save**.
- 6 Select **Duration**.
- 7 Select the amount of time you intend to spend at the location, and select **Save**.
- 8 If necessary, repeat steps 3 through 7 for each location.

## Navigating to a Saved Trip

- 1 Select **Apps > Trip Planner**.
- 2 Select a saved trip.
- 3 Select **Go!**.
- 4 Select your next destination.
- 5 If prompted, select a route.

## Editing a Saved Trip

- 1 Select **Apps > Trip Planner**.
- 2 Select a saved trip.
- 3 Select **≡**.
- 4 Select an option:
  - Select **Edit Destinations** to add and delete a location, or to change the order of locations.
  - Select **Delete Trip**.
  - Select **Rename Trip**.
  - Select **Optimize Order** to arrange the stops on your trip in the most-efficient order.
  - Select **Route Preference** to change the route calculation mode for your trip.

## Saving Trip Logs

Trip logs are recorded while you navigate a route.

**NOTE:** Trip log data is saved as a .gpx file.

- 1 Connect a USB mass storage device to your KENWOOD unit.

- 2 Select **Apps > My Data > Manage Trip Log**.
- 3 Select a trip log segment, or select **View All Segments**.
- 4 Select **Share** to export to the USB mass storage device.

## Viewing Previous Routes and Destinations

Before you can use this feature, you must enable the travel history feature (**Device and Privacy Settings**).

You can view your previous routes and places you have stopped on the map.

Select **Apps > Where I've Been**.

## Viewing the Weather Forecast

Before you can use this feature, your device must be connected using Bluetooth to access connected services. This feature is not available in all areas.

- 1 Select **Apps > Weather**.
- 2 Select a day.

The detailed forecast for that day appears.

## Viewing Weather Near a Different City

- 1 Select **Apps > Weather > Current Location**.
- 2 Select an option:
  - To view weather for a favorite city, select a city in the list.
  - To add a favorite city, select **Add City**, and enter a city name.

## Viewing Road Weather

Before you can use this feature, your device must be connected using Bluetooth wireless technology to access connected services. This feature is not available in all areas.

- 1 Select **Apps > Road Weather**.

Weather events that affect road conditions appear on the map.
- 2 Select a weather event to view details about the event.

## Finding Fuel Stations and Prices

Before you can use this feature, your device must be connected using Bluetooth to access connected services.

You can find nearby fuel stations and compare fuel prices.

- 1 Select **Apps > Fuel Prices**.
- 2 If necessary, select  > **Fuel Type**, select a fuel type, and select **Save**.
- 3 Select a fuel station.

## Dynamic Parking

Before you can use this feature, your device must be connected using Bluetooth to access connected services. This feature is not available in all areas.

You can find detailed parking information, including parking availability in nearby garages and pricing information.

- 1 Select **Apps > Dynamic Parking**.
- 2 Select a parking location.

## About Traffic

### NOTICE

Garmin and JVC KENWOOD are not responsible for the accuracy or timeliness of traffic information.

Your navigation system can receive traffic information with a subscription to INRIX® Traffic Service. The traffic receiver must be in data range of a station transmitting traffic data to receive traffic information. The traffic subscription activates automatically after your navigation system acquires satellite signals while receiving traffic signals from the service provider.

**NOTE:** INRIX Traffic Service is not available on all models or in all areas.

## Traffic Data Using INRIX Traffic Service

You can purchase a traffic subscription to receive traffic data using INRIX traffic service. When your navigation system is connected to INRIX and within a traffic coverage area, your system begins

displaying traffic information. Traffic data is not available in all areas or regions.

See the KENWOOD Traffic Powered By INRIX™ application for INRIX traffic subscription information.

## About the Traffic Icon

When you are receiving traffic information, a traffic icon appears on the map. The traffic icon changes color to indicate the severity of traffic conditions.

**Green:** Traffic is flowing freely.

**Yellow:** Traffic is moving, but there is a delay. There is moderate traffic congestion.

**Red:** Traffic is not moving or moving very slowly. There is a severe delay.



**Gray:** Traffic information is not available.

## Traffic on Your Route

### Viewing Traffic on Your Route

- 1 While navigating a route, select .
- 2 Select **Traffic On Route**.  
A list of traffic events appears, organized by their location on the route.
- 3 Select an event.

### Manually Avoiding Traffic on Your Route

- 1 From the map, select .
- 2 Select **Traffic On Route**.
- 3 If necessary, use the arrows to view other traffic delays on your route.
- 4 Select  > **Avoid**.

### Taking an Alternate Route

- 1 While navigating an automobile route, select .
- 2 Select **Alternate Route**.
- 3 Select a route.

### Viewing Traffic on the Map

The traffic map shows color-coded traffic flow and delays on nearby roads.

- 1 From the map, select .
- 2 Select **Traffic Conditions**.

## Traffic in Your Area

### Searching for Traffic Delays

- 1 From the map page, select .
- 2 Select **Traffic Conditions** > **Q**.
- 3 Select an item in the list.
- 4 If there is more than one delay, use the arrows to view additional delays.

### Viewing a Traffic Incident on the Map

- 1 From the map, select .
- 2 Select **Traffic Conditions**.
- 3 Select a traffic icon.

## Understanding Traffic Data

The traffic legend explains the icons and colors used on the traffic map.

- 1 From the map, select  > **Traffic**.
- 2 Select **Traffic Legend**.

## Customizing the Device

### Map and Vehicle Settings

To open the Map and Vehicle settings, from the main menu, select **Settings** > **Map & Vehicle**.

**Vehicle:** Sets the icon that represents your position on the map.

**Driving Map View:** Sets the perspective on the map.

**Map Detail:** Sets the level of detail on the map. More detail may cause the map to draw slower.

**Map Theme:** Changes the color of the map data.

**Map Buttons:** Sets which icons are included on the map. Up to three icons can be included on the map.

**Map Layers:** Sets the data that appears on the map page ([Customizing the Map Layers](#)).

**Dashboards:** Sets the map dashboard layout.

**Auto Zoom:** Automatically selects the zoom level for optimal use of your map. When disabled, you must zoom in or out manually.

**Audible Speed Alerts:** Alerts you when your vehicle is exceeding the speed limit.

**NOTE:** This feature is not available in all areas.

**myMaps:** Sets which installed maps the device uses.

### Enabling Maps

You can enable map products installed on your device.

- 1 Select **Settings** > **Map & Vehicle** > **myMaps**.
- 2 Select a map.

## Navigation Settings

To open the Navigation settings page, from the main menu, select **Settings** > **Navigation**.

**Calculation Mode:** Sets the route calculation method.

**Avoidances:** Sets road features to avoid on a route.

**Custom Avoidances:** Allows you to avoid specific roads or areas.

**Advanced Detours:** Sets the length of the detour.

**Safe Mode:** Disables all functions that require significant operator attention and could become a distraction while driving.

**Voice Prompts:** Enables voice prompts.

**GPS Simulator:** Stops the device from receiving a GPS signal.

### Changing the Route Calculation Mode

- 1 Select **Settings** > **Navigation** > **Calculation Mode**.
- 2 Select an option:
  - Select **Faster Time** to calculate routes that are faster to drive but can be longer in distance.
  - Select **Shorter Distance** to calculate routes that are shorter in distance but can take more time to drive.
  - Select **Less Fuel** to calculate routes that are more fuel-efficient.
- 3 Select **Save**.

## Display Settings

Select **Settings** > **Display**.

**Color Mode:** Allows the device to display day or night colors.

### Changing the Color Mode

- 1 Select **Settings** > **Display** > **Color Mode**.
- 2 Select an option:
  - To use a light background, select **Day**.
  - To use a dark background, select **Night**.
  - To allow the device to display day or night colors automatically, based on the time of day, select **Auto**.

## Traffic Settings

From the main menu, select **Settings** > **Traffic**.

**Traffic:** Enables traffic.

**Subscriptions:** Lists the current traffic subscriptions.

**trafficTrends™:** Enables the trafficTrends™ feature ([trafficTrends](#)).

**Traffic Voice Prompts:** Enables voice prompts for traffic events.

### trafficTrends

When the trafficTrends feature is enabled, your device uses historic traffic data to calculate more-efficient routes.

**NOTE:** Different routes may be calculated based on traffic trends for the day of the week or the time of day.

### Disabling trafficTrends

To prevent your device from recording traffic data, you must disable trafficTrends.

Select **Settings** > **Traffic** > **trafficTrends™**.

## Units and Time Settings

To open the Units and Time settings page, from the main menu, select **Settings** > **Units & Time**.

**Current:** Sets the device time.

**Time Format:** Allows you to select a 12-hour, 24-hour, or UTC display time.

**Units:** Sets the unit of measure used for distances.

## Language and Keyboard Settings

To open the Language and Keyboard settings, from the main menu, select **Settings** > **Language & Keyboard**.

**NOTE:** To change the text language settings, see the KENWOOD system instruction manual.

**Voice Language:** Sets the language for voice prompts.

**Keyboard Language:** Sets the language for your keyboard.

**Keyboard Layout:** Sets the keyboard layout.

## Device and Privacy Settings

To open the Device settings page, from the main menu, select **Settings** > **Device**.

**About:** Displays the software version number, the unit ID number, and information on several other software features.

**Travel History:** Allows the device to record information for the myTrends ([Using Suggested Routes](#)), Where I've Been ([Viewing Previous Routes and Destinations](#)), and Trip Log ([Viewing the Trip Log](#)) features.

**Clear Travel History:** Clears your travel history from the navigation system.

**Update Maps:** Exports data from the navigation unit for map and software updates ([Updating Map Data](#)).

## Proximity Alerts Settings

**NOTE:** You must have custom points of interest (POIs) loaded for proximity points alerts to display.

**NOTE:** This feature is not available in all areas.

Select **Settings** > **Proximity Alerts**.

**Audio:** Sets the style of alert that plays when you approach proximity points.

**Alerts:** Sets the type of proximity points for which alerts are played.

## Restoring Settings

You can restore a category of settings or all settings to the factory default values.

- 1 Select **Settings**.
- 2 If necessary, select a settings category.
- 3 Select  > **Restore**.
- 4 Select **Yes**.

To download free navigation software updates and purchase updated maps for your product, go to [www.garmin.com/kenwood](http://www.garmin.com/kenwood).



## MILITARY

Units purchased through the U.S.A. military exchange service overseas may be serviced under warranty in the continental U.S.A., subject to the following conditions.

- 1) The original warranty is in effect.
- 2) Proof of purchase is provided to the servicer.

### WARRANTY FOR MILITARY MARKET

JVC KENWOOD corporation is proud of the quality and workmanship of its audio equipment. This unit has been properly designed, tested and inspected before it was shipped to you. If properly installed and operated in accordance with instructions furnished, it should give you an optimum reliable performance.

### WARRANTY PERIOD

This product is warranted for a period of (1) year from the date of the original purchase.

### SCOPE OF WARRANTY

Except as specified below, this warranty covers all defects in materials and workmanship of the Kenwood brand products.

During the warranty period, any authorized Kenwood Service Center in the military market listed in the back of this warranty card will provide you free-of-charge both parts and labor required to correct any defect in materials or workmanship.

The following are not covered by this warranty.

1. Voltage conversions.
2. Periodic check-ups which do not disclose any defect covered by the warranty.
3. Cabinets, grilles, other exterior finishes, belts, tape heads, and other non-durable parts and accessories.
4. Units on which the serial number has been effaced, modified or removed.
5. Installation and/or removal charges.
6. Damaged magnetic tapes.
7. House call charges for any repairs.
8. Shipping or delivery charges to or from an authorized Kenwood Service Center.
9. This warranty will not cover any failure that is due to any of the following conditions in accordance with the visual inspection of the authorized Kenwood Service Center:
  - \* Improper maintenance or repair, including the installation of parts or accessories that do not conform to the quality and specifications of the original parts.
  - \* Misuse, abuse, neglect, unauthorized product modification or failure to follow instructions contained in the Owner's Manual.
  - \* Accidental or intentional damages.
  - \* Repairs or attempted repairs by an unauthorized agency. (All repairs must be performed at an authorized Kenwood Service Center.)
  - \* Damages or deteriorations caused during shipment. (Claims must be presented to the carrier).
  - \* Damages or deteriorations resulting from removal and/or replacement.

### PURCHASER'S RESPONSIBILITIES

As the purchaser of a new Kenwood brand product, you are requested to do the following in order to obtain Kenwood warranty service.

1. Retain your sales slip or other evidence of purchase for proving your eligibility for requesting Kenwood warranty service.
2. Make your unit available to an authorized Kenwood Service Center in the military market for inspection and approved warranty service, or ship your unit in its original carton box or equivalent, fully insured and shipping charges prepaid, to the authorized Kenwood Service Center.

### LIMITATION OF IMPLIED WARRANTIES

Any and all implied warranties, including warranties of merchantability and fitness for a particular purpose, shall be limited in duration to the length of this warranty.

### EXCLUSION OF CERTAIN DAMAGES

KENWOOD's liability for any defective product is limited to the repair or replacement of said product, at our option, and shall not include damages of any kind, whether incidental, consequential or otherwise, except to the extent prohibited by applicable law.

### KENWOOD AUTHORIZED SERVICE CENTERS IN MILITARY MARKET

#### JAPAN:

**Yokota**  
Kenwood Rep.; c/o  
Yokota BX, JAAX AAFES-PAC,  
APO San Francisco 96328

#### Zama

Kenwood Rep.; c/o  
Zama PX, JAAX AAFES-PAC,  
APO San Francisco 96343

#### Misawa

Kenwood Rep.; c/o  
Misawa BX, JAAX AAFES-PAC,  
APO San Francisco 96519

#### Yokosuka

Kenwood Rep.; c/o  
A-33, Yokosuka NEX No. 260-010  
FPO Seattle 98760

#### Atsugi

Kenwood Rep.; c/o  
Atsugi NEX No. 260-020 FPO Seattle  
98767

#### Iwakuni

Kenwood Rep.; c/o  
Marine Corps Exchange, Marine Corps  
Air Station,  
FPO Seattle 98764

#### Sasebo

Sasebo NEX;  
Navy Exchange 260-040  
F.A. Box 115 FPO Seattle 98766

#### Okinawa

Kenwood Rep.; c/o  
OWAX, AAFES-PAC, APO San Francisco  
96230

#### KOREA:

Kenwood Rep.; c/o  
KOAX Repair Shop, AAFES-PAC  
DD-Camp Market, APO San Francisco  
96488

#### GUAM:

Kenwood Rep.; c/o  
Guam NEX No. 230-010,  
FPO San Francisco 96630  
Kenwood Rep.; c/o  
GUAX, AAFES-PAC, APO San Francisco  
96334

#### U.S.A.:

**In The Continental U.S.A.**  
For Nearest Authorized Service Center;  
Tel: 1-800-536-9663  
www.us.jvckenwood.com

#### EUROPE:

Please inquire at the military resale outlets where you bought your Kenwood products, or  
JVCKENWOOD DEUTSCHLAND GMBH:  
Konrad-Adenauer Allee 1-11, 61118 Bad  
Vilbel, Germany

# KENWOOD

# Warranty Card

Identification du produit  
Modelo do aparelho e numero de série  
Model number & serial number

Revendeur & cachet  
Nome da loja e carimbo  
Dealer & stamp

Date d'achat  
Data da compra  
Purchase date

Nom & adresse du client  
Nome e endereço do cliente  
Name & address of customer

### Attention:

This card and receipt (or invoice) are necessary to purchase a new panel in case of theft or damage.

### Attention:

Vous aurez besoin de cette carte et du reçu (ou de la facture) pour acheter un nouveau panneau en cas de vol ou d'endommagement.

### Atenção:

Em caso de dano ou perda do painel frontal, este Certificado de Garantia e a Nota Fiscal de compra serão requisitados para a aquisição de um novo painel.

© B46-0824-00/04 (K) (15/11)

Dear Customer,

Thank you for purchasing this Kenwood product. As mentioned in the pages of this booklet, our warranty is only valid in the countries listed. If your country is not listed please contact your retailer for information on warranty procedure, or write to:

### JVC KENWOOD Customer Information Center

3-12, Moriyacho, Kanagawa-ku, Yokohama-shi, Kanagawa 221-0022, Japan

**U.S.A.**  **JVCKENWOOD USA Corporation**

This warranty will be honored only in the U.S.A.

**KENWOOD LIMITED WARRANTY FOR CAR STEREO COMPONENTS**

**HOW LONG IS THE WARRANTY**  
JVCKENWOOD USA Corporation ("Kenwood") warrants this product for a period of one (1) year from the date of original purchase.

**WHAT IS COVERED AND WHAT IS NOT COVERED**

Except as specified below, this warranty covers all defects in material and workmanship in Kenwood car stereo components. The following are not covered by the warranty:

- Any product which is not distributed in the U.S.A. by Kenwood or which is not purchased in the U.S.A. from an authorized Kenwood car stereo dealer or an automobile dealer, unless the product is purchased through the U.S.A Military Exchange Service.
- Any product on which the serial number has been defaced, modified or removed.
- Damage, deterioration or malfunction resulting from:
  - Any shipment of the product (claims must be presented to the carrier).
  - Installation or removal of the product.
  - Accident, acts of nature, misuse, abuse, neglect, unauthorized product modification or failure to follow instructions supplied with the product.
  - Repair or attempted repair by anyone not authorized by Kenwood.
  - Any other cause which does not relate to a product defect.

**WHO IS PROTECTED**  
This warranty is enforceable only by the original purchaser.

**WHAT WE WILL PAY FOR**  
We will pay for all labor and material expenses for covered items. Payment of shipping charges is discussed in the next section of this warranty.

**HOW TO OBTAIN WARRANTY SERVICE**

If your KENWOOD product ever needs service:  
1. Take or ship it to any KENWOOD Authorized Service Center in the U.S.A. along with & complete description of the problem. (If you are uncertain as to whether a Service Center is authorized, please call 1-800-KENWOOD for the nearest Service Center. 1-800-536-9663).

- Although you must pay any shipping charges if it is necessary to ship the product for warranty service, we will pay the return shipping charges if the repairs are covered by the warranty within the United States.
- Whenever your units are taken or sent for warranty service, you must include a copy of the original dated sales receipt as proof of warranty coverage.

**LIMITATION OF IMPLIED WARRANTIES**

ALL IMPLIED WARRANTIES, INCLUDING WARRANTIES OF MERCHANTABILITY AND FITNESS FOR A PARTICULAR PURPOSE, ARE LIMITED IN DURATION TO THE LENGTH OF THIS WARRANTY.

**EXCLUSION OF DAMAGES**  
KENWOOD'S LIABILITY FOR ANY DEFECTIVE PRODUCT IS LIMITED TO THE REPAIR OR REPLACEMENT OF THE PRODUCT AT OUR OPTION. KENWOOD SHALL NOT BE LIABLE FOR:  
1. INSTALLATION OR REMOVAL CHARGES, DAMAGE TO OTHER PROPERTY CAUSED BY ANY DEFECTS IN KENWOOD CAR STEREO COMPONENTS, DAMAGES BASED UPON INCONVENIENCE, LOSS OF USE OF THE PRODUCT; OR  
2. ANY OTHER DAMAGES, WHETHER INCIDENTAL, CONSEQUENTIAL OR OTHERWISE.  
SOME STATES DO NOT ALLOW LIMITATIONS ON HOW LONG AN IMPLIED WARRANTY LASTS AND/OR DO NOT ALLOW THE EXCLUSION OR LIMITATION OF INCIDENTAL OR CONSEQUENTIAL DAMAGES. SO THE ABOVE LIMITATIONS AND EXCLUSIONS MAY NOT APPLY TO YOU.

This warranty gives you specific legal rights, and you may also have other rights which vary from state to state.

If a problem develops during or after the Limited Warranty Period, or if you have any questions regarding the operation of the product, you should contact your KENWOOD Authorized Dealer or Authorized Service Center. If the problem or your question is not handled to your satisfaction, please contact our Customer Relations Department at the address listed below:

**JVCKENWOOD USA Corporation**  
**PO Box 22745, 2201 E. Dominguez St.**  
**Long Beach, CA 90810-5745**  
**Tel: (800) 536-9663**  
**www.us.jvckenwood.com**

**BRASIL** **JVC KENWOOD DO BRASIL COMÉRCIO DE ELETRÔNICOS LTDA**

O fabricante garante o produto identificado na Nota Fiscal de venda ao consumidor contra qualquer defeito de fabricação ou de matéria-prima durante o período de garantia. Esta garantia é válida no território brasileiro desde que o produto tenha sido adquirido no Brasil e distribuído pela JVC KENWOOD do Brasil Comércio de Eletrônicos Ltda.

**PERÍODO DE GARANTIA**

Este produto é garantido pelo prazo de 01 (um) ano, incluindo o período estabelecido por lei, a partir da data de aquisição, comprovada mediante a apresentação da respectiva Nota Fiscal de venda ao consumidor final. Eventuais reparos realizados no produto durante o período de garantia não implicam na dilatação do seu prazo.

**EXCLUSÃO DA GARANTIA**

- Produtos com o número de série ou certificado de garantia rasurados, adulterados ou ilegíveis;
- Defeitos resultantes de acidentes (quedas, batidas e etc), uso em desacordo com o manual de instruções, má utilização, ligação à fonte de tensão diferente da especificada no Manual de Instruções, modificações não autorizadas;
- Danos causados por agentes da natureza (Ex: chuvas, raios, maresia, enchentes e etc);
- Defeitos ou danos em decorrência de consertos realizados por pessoas não autorizadas;
- Defeitos ou danos resultantes do uso de peças ou dispositivos não conformes às especificações da JVC KENWOOD;
- Danos ou deteriorações aos acabamentos externos, partes cosméticas, cabos, chicotes, parafusos de fixação, luvas, alças, bolsas, estojos, adaptadores, antenas, fitas, cabeças gravadoras, CDs ou danos causados por pilhas defeituosas ou com vazamento;
- Defeitos ou danos devido ao transporte (reclamações devem ser feitas junto à empresa transportadora);
- Qualquer outra causa que não esteja relacionada a defeitos de matéria-prima e de fabricação;
- Danos causados por tentativa de roubo ou furto;
- Danos causados por uso de CDs de má qualidade;
- Danos decorrentes do desgaste natural do produto;
- Danos causados por mau uso. (derramamento de líquidos e/ou alimentos, corrosão, oxidação, exposição à umidade ou situações climáticas extremas, riscos ou quedas).

**CONCERTO EM GARANTIA**

É indispensável a apresentação deste Certificado de Garantia devidamente preenchido, acompanhado da respectiva Nota Fiscal de compra do produto, desde que não apresente rasuras ou modificações. O consumidor somente terá direito a estes benefícios, quando o produto for entregue diretamente no balcão de um Serviço Autorizado da JVC KENWOOD.

**O QUE NÃO É COBERTO PELA GARANTIA**

Instalação e remoção do produto, despesas de frete, seguro e embalagem são de responsabilidade do proprietário.

Este produto é destinado exclusivamente ao uso doméstico.

**IMPORTANTE:**

Para qualquer informação sobre seu equipamento JVC KENWOOD, ou para obter o endereço do Serviço Autorizado mais próximo, acesse o site [www.kenwood.com.br](http://www.kenwood.com.br), ou ligue para a Central de Atendimento JVC KENWOOD – Tel.: +55 (11) 3777-6771 com os dados abaixo preenchidos.

**JVC KENWOOD DO BRASIL COMÉRCIO DE ELETRÔNICOS LTDA**  
**Tel: (11) 3777-6771**  
**www.kenwood.com.br**

Nome do consumidor: \_\_\_\_\_

Endereço: \_\_\_\_\_ CEP: \_\_\_\_\_

Cidade: \_\_\_\_\_ Estado: \_\_\_\_\_

Telefone: \_\_\_\_\_

Data da compra: \_\_\_\_ / \_\_\_\_ / \_\_\_\_ Nota Fiscal: \_\_\_\_\_

**CANADA** **JVCKENWOOD Canada Inc.**

**KENWOOD WARRANTY**  
JVCKENWOOD Canada Inc. (hereinafter called "KENWOOD"), gives the following written warranty to the original customer of each new Kenwood product distributed in Canada by KENWOOD and purchased from a dealer authorized by KENWOOD.

KENWOOD warrants that each new Kenwood product, under normal use, is free from any defects, subject to the terms and conditions set forth below. If a defect should occur within the warranty period, repairs will be made free of charge for parts and labour when such defects are determined by KENWOOD or its' authorized service centres to be attributable to faulty materials or workmanship at time of manufacture. Please contact KENWOOD to confirm if a dealer or service centre is authorized by KENWOOD.

**WARRANTY PERIOD**

This Kenwood product is warranted for parts and labour for a period of one (1) year from the date of original purchase, lease or rental, except for products which are used in a professional or commercial application, which are warranted for a period of ninety (90) days for parts and labour and are subject to the terms and conditions of the warranty.

**WARRANTY EXCLUSIONS**

- This warranty excludes:
- Products purchased in a foreign country or purchased in Canada and taken to a foreign country.
  - Products purchased from a dealer not authorized by KENWOOD.
  - Products with the serial number defaced, altered or missing.
  - Periodic check-ups which do not disclose any defects covered by this warranty.

- Defects resulting from disaster, accident, abuse, misuse, lightning, power surges, neglect or lack of periodic maintenance, unauthorized modification or failure to follow instructions in the owner's manual.
- Defects or damage as a result of repairs performed by a person or party not authorized by KENWOOD.
- Defects resulting from the use of parts or devices that do not conform to KENWOOD specifications.
- Damage or deterioration occurring to any exterior finishes, cosmetic parts, tape heads, adaptors, antennas, cables, tapes, discs or faults or damage caused by defective or leaking batteries.
- Defects or damage occurring during shipping (claims should be presented to the shipping company).
- Product voltage and /or line frequency conversions.
- Product installation or removal charges.

**TO OBTAIN WARRANTY SERVICE**

Should your Kenwood product require warranty service, deliver it to any authorized KENWOOD service centre and present the original copy of your bill of sale and this warranty card as proof of warranty, or send your product fully insured and freight prepaid to the nearest authorized KENWOOD service centre. To avoid possible shipping damage, make sure the product is properly packed. Include a copy of your original bill of sale and this warranty card as proof of warranty along with your name, home and /or work telephone number(s), a complete return address and a detailed description of the fault(s). Products repaired within warranty will be returned freight prepaid to destinations within Canada. The customer is responsible for all freight and related costs for the return of product(s) to destinations outside Canada.

**ENTIRE WARRANTY**  
This warranty constitutes the entire written warranty given by KENWOOD. No person, party, dealer or service centre or their agents or employees are authorized to extend or enlarge this warranty on behalf of KENWOOD by any written or verbal statement or advertisement or promotion, including any extended warranty program or plan that may be offered by the dealer or service centre, unless approved in writing by KENWOOD.

**DISCLAIMER**

KENWOOD disclaims any responsibility for loss of time or use of the product or any other indirect, incidental or consequential damage to other products or goods, inconvenience or commercial loss.

**NOTICE TO CONSUMER**

The provisions contained in this written warranty are not intended to limit, modify, take away, disclaim or exclude any warranties or rights you may have which are set forth in any applicable provincial or federal laws or legislation.

**IMPORTANT**

This warranty card by itself is not considered by KENWOOD as a valid proof of purchase. When applying for warranty repairs, you must present the original copy of your bill of sale and this warranty card as proof of warranty, so we recommend that they be kept in a safe place, should they be required in the future.

**JVCKENWOOD Canada Inc.**  
**6070 Kestrel Road, Mississauga,**  
**Ontario, Canada L5T 1S8**  
**Tel.: (905) 670-7211**  
**Fax: (905) 670-7248**

**GARANTIE KENWOOD**

JVCKENWOOD Canada Inc. (ci-après appelée "KENWOOD"), donne par écrit la garantie suivante à l'acheteur original de chaque nouveau produit Kenwood distribué au Canada par KENWOOD et acheté à un concessionnaire autorisé par KENWOOD.

KENWOOD garantit, sous réserve des termes et des conditions énoncés ci-dessous, que chaque nouveau produit Kenwood, dans des conditions d'emploi normales, est exempt de tous défauts. Si l'un défaut se produit pendant la période de garantie, KENWOOD s'engage à assumer le coût des pièces défectueuses et de la main-d'œuvre nécessaires pour effectuer les réparations pourvu que de tels défauts sont attribuables à des pièces défectueuses employées lors de la fabrication du produit Kenwood ou à la main-d'œuvre tel qu'établi par KENWOOD ou par l'un des centres de service autorisés. Appelez KENWOOD pour vérifier si un concessionnaire ou un centre de service est autorisé par KENWOOD.

**PÉRIODE DE GARANTIE**

Les pièces et la main-d'œuvre nécessaires pour la réparation des produits Kenwood sont garanties pendant la période d'un (1) an à compter de la date d'achat, de bail ou de location originale, sauf dans les cas où les produits Kenwood sont employés dans un but professionnel ou commercial, où la garantie des pièces et de la main-d'œuvre demeure en vigueur pendant une période de quatre-vingt-dix (90) jours sous réserve des termes et des conditions de la garantie.

**EXCLUSIONS DE GARANTIE**

- Cette garantie ne couvre pas:
- les produits achetés à l'étranger ou achetés au Canada et transportés à l'étranger;
  - les produits achetés à un concessionnaire non autorisé par KENWOOD;
  - les produits dont le numéro de série manque, a été effacé ou modifié;
  - des services d'entretien périodiques qui n'indiquent aucun défaut couvert par cette garantie;

- les défauts causés par les désastres, les accidents, les abus, les emplois incorrects, les éclairs, les surtensions de courant, les manques de soins ou d'entretiens périodiques, les modifications non autorisées ou les manques de respect du mode d'emploi;
- les défauts ou les dommages causés lors de réparations effectuées par une personne ou par une partie non autorisée par KENWOOD;
- les défauts causés par l'emploi de pièces ou de dispositifs qui ne se conforment pas aux exigences de KENWOOD;
- les finitions extérieures, les pièces cosmétiques, les têtes de bandes, les adaptateurs, les antennes, les câbles, les bandes, les disques endommagés ou déperis, ni les défauts ou dommages causés par des piles défectueuses ou qui fuient;
- les défauts ou dommages qui se produisent pendant l'expédition des produits Kenwood (On devrait déposer de telles réclamations auprès des compagnies de transport);
- les conversions de tension et/ou de fréquence du produit;
- les frais d'installation ou d'enlèvement du produit.

**COMMENT OBTENIR DU SERVICE SOUS GARANTIE**

Au cas où un service sous garantie de votre produit Kenwood s'avère nécessaire, veuillez livrer le produit à n'importe quel centre de service KENWOOD et présenter la copie originale du contrat de vente et cette carte de garantie en tant que preuve de garantie ou veuillez faire parvenir votre produit assuré et port payé au centre de service KENWOOD autorisé le plus proche. Pour éviter toutes possibilités de dommages pendant le transport, veuillez bien emballer le produit. Veuillez inclure une copie du contrat de vente original et cette carte de garantie en tant que preuve de garantie aussi bien que votre nom, numéros de téléphone au poste de travail et/ou au domicile, votre adresse et une description détaillée des défauts. Les produits sous garantie réparés seront retournés port payé aux destinations à l'intérieur du Canada. Le consommateur sera responsable de tous frais de transport et d'autres frais qui s'y rapportent pour faire expédier les produits à destinations à l'extérieur du Canada.

**L'ENTIERE GARANTIE**

Cette garantie représente l'entière garantie donnée par écrit par KENWOOD. KENWOOD ne se tient aucunement responsable de toutes extensions ni de toutes augmentations de cette garantie faites ou entreprises par toutes personnes, parties, concessionnaires ou centres de service ou par leurs agents ou employés au nom de KENWOOD au moyen d'affirmations verbales ou écrites, d'annonces ou de promotions, y inclut tous programmes ou plans de garantie étendue que puissent offrir les concessionnaires ou les centres de service, à moins que KENWOOD n'y ait consenti par écrit d'avance.

**RENONCIATION**

KENWOOD renonce à toutes responsabilités de perte de temps, d'emploi du produit, de tous dommages indirects ou accessoires causés à d'autres produits ou biens, de tous inconvénients ou de toutes pertes commerciales.

**AVIS AUX CONSOMMATEURS**

Les stipulations contenues dans la présente garantie écrite n'ont pas pour but de limiter, de modifier, de diminuer, de rejeter ni d'exclure d'autres garanties ni droits énoncés dans n'importe quelles lois ou législations provinciales ou fédérales.

**IMPORTANT**

KENWOOD ne considère pas cette garantie toute seule comme étant une preuve d'achat valide. Lorsqu'on demande du service sous garantie, il faudra présenter la copie originale du contrat de vente aussi bien que cette carte de garantie en tant que preuve de garantie. On recommande de les conserver dans un lieu sûr au cas où elles s'avèreraient nécessaires à l'avenir.

**JVCKENWOOD Canada Inc.**  
**6070 Kestrel Road, Mississauga,**  
**Ontario, Canada L5T 1S8**  
**Téléphone: (905) 670-7211**  
**Télécopieur: (905) 670-7248**